

REVISION INFORMATION (Vender)			
Rev.	Rev. Date	Modified By	Brief Description
1.0	DEC. 24, 24	Alvin Shi	Initial Release

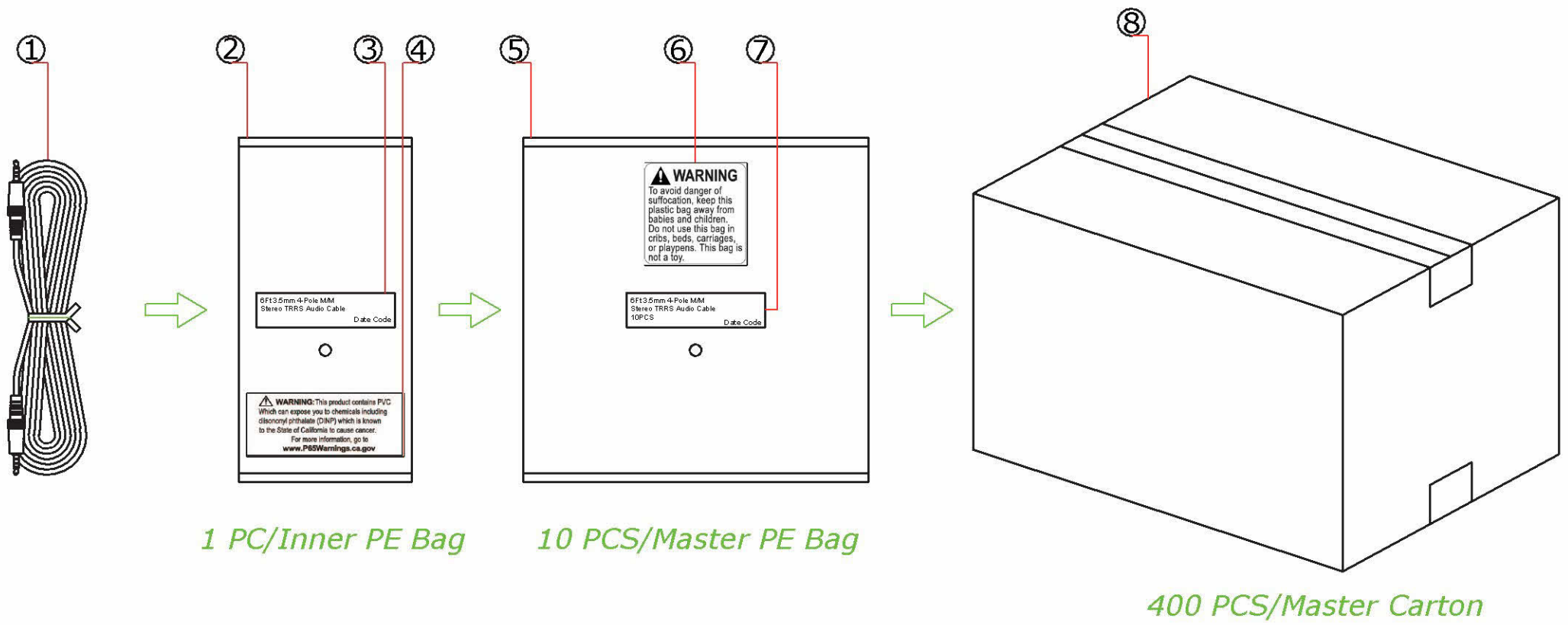

⑧	Carton	400PCS Pack Unit 5-Ply Carton, 39 x 33 x 26 CM	1	PC
⑦	Lable	10PCS Pack Unit Lable with Date Code	1	PC
⑥	PE Bag	Master PE Bag, 20 x 22 CM	1	PC
⑤	Lable	P65 Lable	1	PC
④	Lable	1PC Pack Unit Lable with Date Code	1	PC
③	Lable	Warning Lable	1	PC
②	PE Bag	Inner PE Bag, 8 x 20 CM	1	PC
①	Cable	6Ft 3.5mm 4-Pole M/M Stereo TRRS Audio Cable, Black	1	PC
NO.	PART NAME	SPECIFICATION DESCRIPTION	Q'TY	UNIT

Unless specified on the drawing, tolerances are per the follows:

. +1
 .x +0.2
 .xx +0.05

VENDOR CODE : PS00831		DESCRIPTION : BestLink 6Ft 3.5mm 4-Pole M/M Stereo TRRS Audio Cable - Black	
APPROVED BY PM & DATE :		PID # : 201453	
PM PRINT NAME :		DATE : 12/24/24	UNIT : MM
		SHEET : 2 OF 4	FILE NAME : PID_201453

REVISION INFORMATION (Vender)			
Rev.	Rev. Date	Modified By	Brief Description
1.0	DEC. 24, 24	Alvin Shi	Initial Release

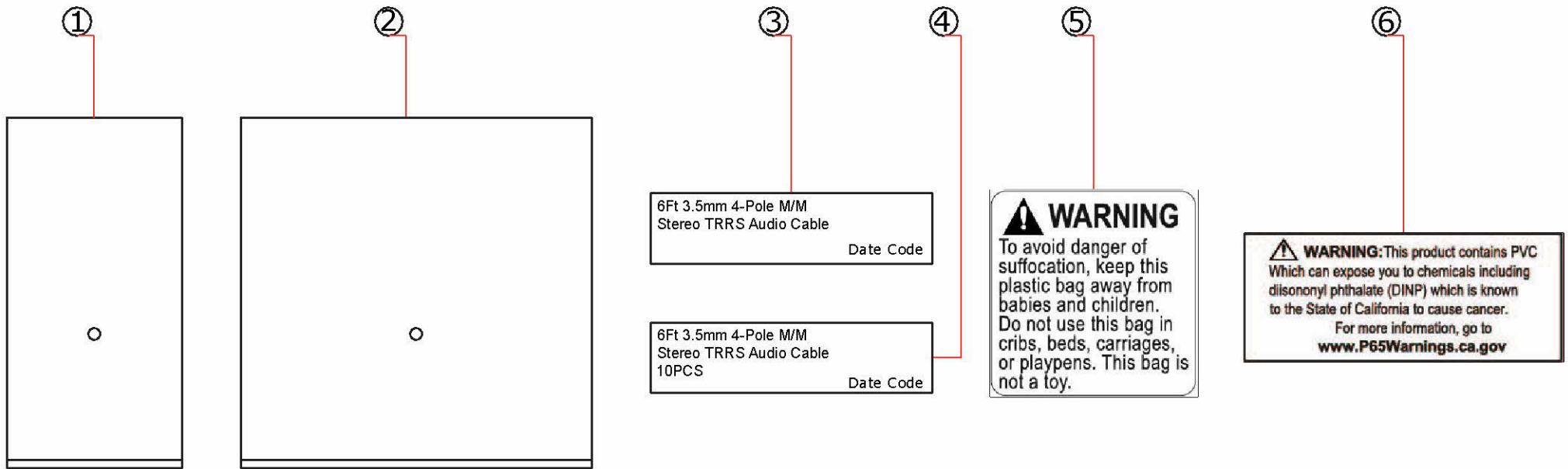

6Ft 3.5mm 4-Pole M/M
Stereo TRRS Audio Cable
Date Code

6Ft 3.5mm 4-Pole M/M
Stereo TRRS Audio Cable
10PCS
Date Code

WARNING
To avoid danger of suffocation, keep this plastic bag away from babies and children. Do not use this bag in cribs, beds, carriages, or playpens. This bag is not a toy.

WARNING: This product contains PVC Which can expose you to chemicals including diisononyl phthalate (DINP) which is known to the State of California to cause cancer. For more information, go to www.P65Warnings.ca.gov

⑥	Lable	P65 Lable	1	PC
⑤	Lable	Warning Lable	1	PC
④	Lable	10PCS Pack Unit Lable with Date Code	1	PC
③	Lable	1PC Pack Unit Lable with Date Code	1	PC
②	PE Bag	Master PE Bag, 20 x 22 CM	1	PC
①	PE Bag	Inner PE Bag, 8 x 20 CM	1	PC
NO.	PART NAME	SPECIFICATION DESCRIPTION	Q'TY	UNIT

Unless specified on the drawing, tolerances are per the follows:
 . +1
 .x +0.2
 .xx +0.05

VENDOR CODE : PS00831		DESCRIPTION : BestLink 6Ft 3.5mm 4-Pole M/M Stereo TRRS Audio Cable - Black	
APPROVED BY PM & DATE :		PID # : 201453	
PM PRINT NAME :	DATE :	UNIT : MM	SHEET : 3 OF 4
		FILE NAME : PID_201453	

Rev.	Rev. Date	Modified By	Brief Description
1.0	DEC. 24, 24	Alvin Shi	Initial Release

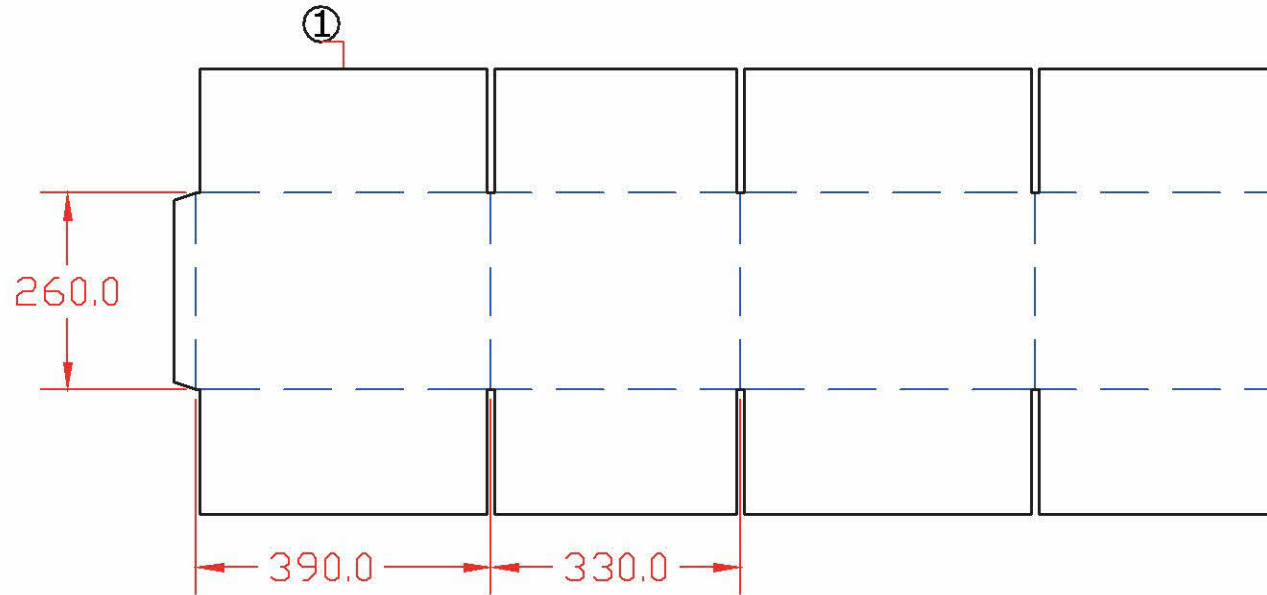

400 PCS/Master Carton



VENDOR CODE : PS00831		DESCRIPTION : BestLink 6Ft 3.5mm 4-Pole M/M Stereo TRRS Audio Cable - Black	
APPROVED BY PM & DATE :		PID # : 201453	
PM PRINT NAME :		DATE :	UNIT : MM
		SHEET : 4 OF 4	FILE NAME : PID_201453

Unless specified on the drawing, tolerances are per the follows:
 . +1
 .x +0.2
 .xx +0.05

NO.	PART NAME	SPECIFICATION DESCRIPTION	CBM	Q'TY	G.W.	N.W.
①	Carton	400PCS Pack Unit 5-Ply Carton, 39 x 33 x 26 CM	0.0335	400PCS	18.2KGS	17.6KGS