

NOTE: ALL MATERIAL COMPLIANT ROHS STANDARD

REVISION INFORMATION			
Rev.	Rev. Date	Modified By	Brief Description
A/1	13-11-05	T1105A	Add Labie
A/2	14-01-10	B0110A	Modify the core sequence
A/3	16-07-04	B0701A	Increment LABLE
A/4	17-07-31	B0728A	modification TOTM

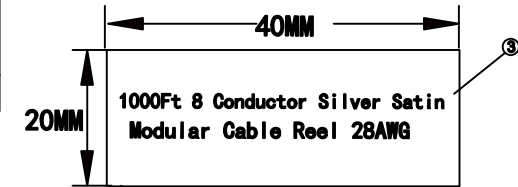

Label (1): White color with black Marking on paper reel

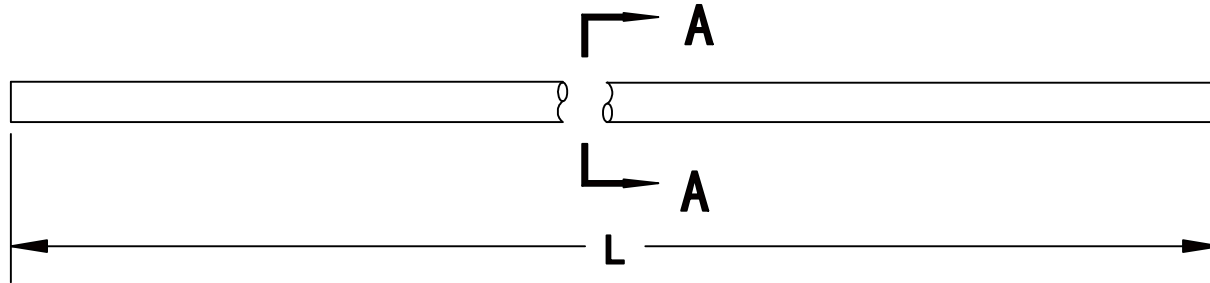
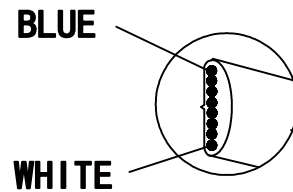
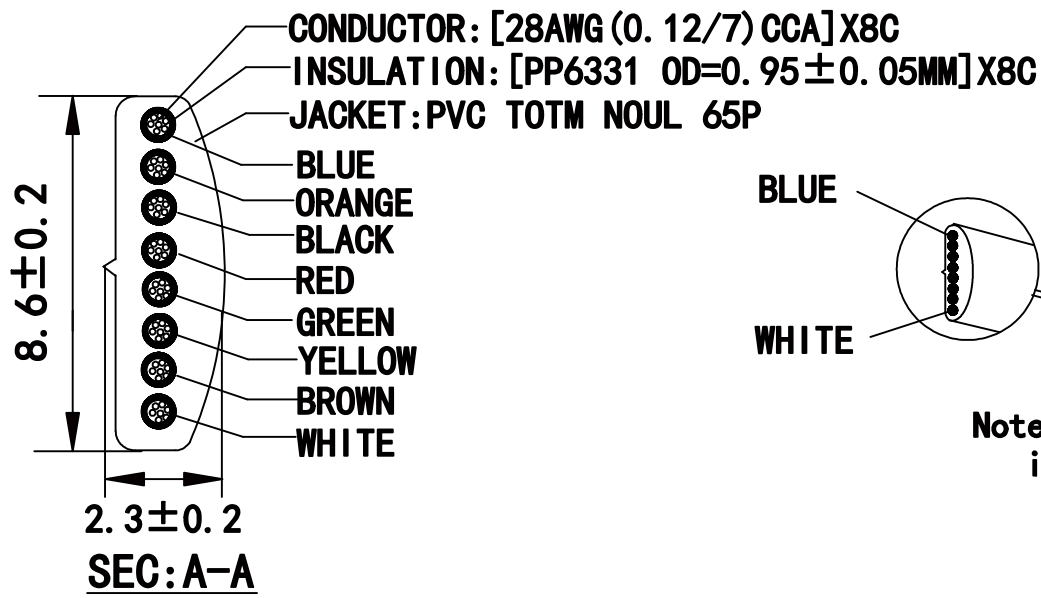

Note :cable direction and inner color sequence

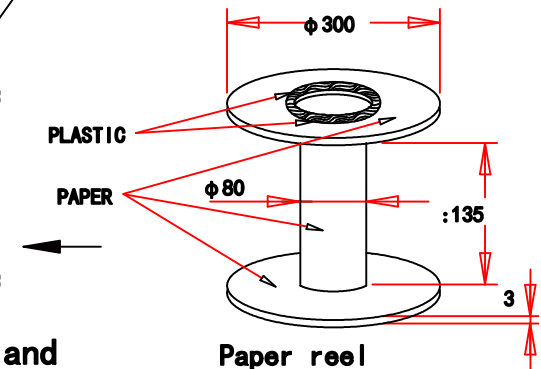

1000 ft/R with PE Film

PART NO	DRAWING NO	CABLE LENGHT "L"	BUYER COLOR	VENDOR COLOR
170203	217-040-A	1000FT/R		S49-1 LIGHT

★. Test condition :100% Electronic Test

NO.	PART NAME	SPECIFICATION DESCRIPTION	QTY	UNIT
⑥	LABLE (3)	50X20MM Black word in white bottom	1	PCS
④	LABLE (2)	10X5MM Black word in white bottom	1	PCS
③	LABLE (1)	40X20MM White color with black Marking	1	PCS
②	Paper reel	φ 300X φ 80X135X3MM Two ends with plastic head, as above	1	PCS
①	CABLE	1000FT/R 28AWG 8C	1	PCS



DRAWN BY:	DATE: 2017/07/31	DESCRIPTION: 1000FT/R 8C 28AWG CABLE
CHECKED BY	SHEET 1 of 3	ITEM NO. 170203
APPROVED BY	SCALE 1:1	REV. A/4 UNIT: mm

NOTE: ALL MATERIAL COMPLIANT ROHS STANDARD

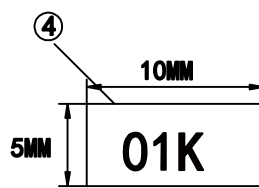

LABLE (2)

Decals material:copperplate paper
Form of written:Arial
Form of written size:9px
Label size:10X5MM

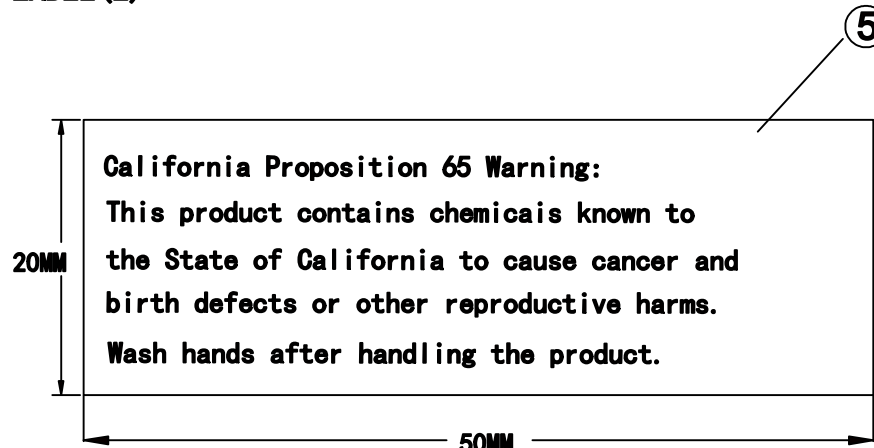

LABLE (3)

Form of written:Arial
Form of written size:6.5px
Label size:50X20MM
Decals material:copperplate paper



DRAWN BY:	DATE: 2017/07/31	DESCRIPTION: 1000FT/R 8C 28AWG CABLE
CHECKED BY	SHEET 2 of 3	ITEM NO. 170203
APPROVED BY	SCALE 1:1	REV. A/4 UNIT: mm 

NOTE: ALL MATERIAL COMPLIANT ROHS STANDARD

Main Mark

P/O:
P/N:
Q'TY:
C/NO.:

MADE IN CHINA

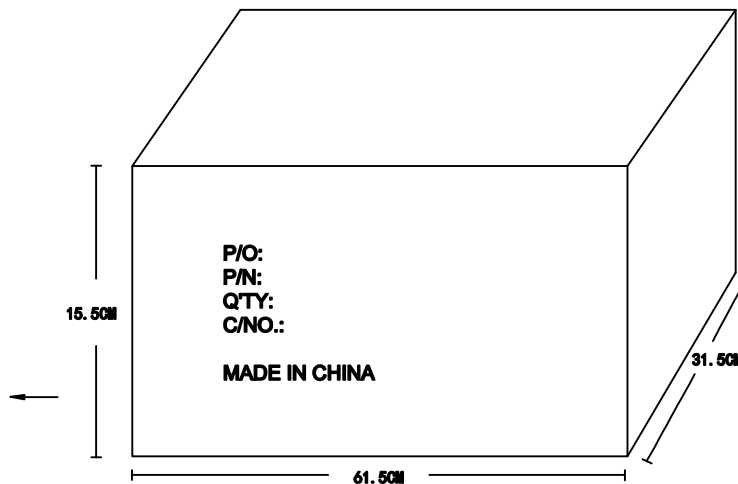

Side Mark





**RoHS
Compliant**

P/N:

Q'TY: PCS

N.W.: KGS

G.W.: KGS

Date Code: 35-2011

Vender Code: PS00788

PART NO	ITEM NO	CABLE OVERALL LENGTH "L"	BOX SIZE (CM)	QTY
170203	217-040-A	1000FT/R	61.5X31.5X15.5CM	2



DRAWN BY:	DATE: 2017/07/31	DESCRIPTION: 1000FT/R 8C 28AWG CABLE
CHECKED BY	SHEET 3 of 3	ITEM NO. 170203
APPROVED BY	SCALE 1:1	REV. A/4 UNIT: mm 