

Small zip lock bag tag:

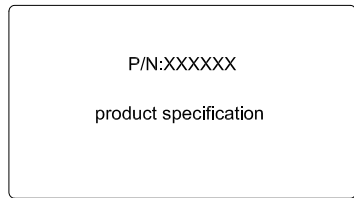

70×38mm

Large Zip-lock Bag Label:

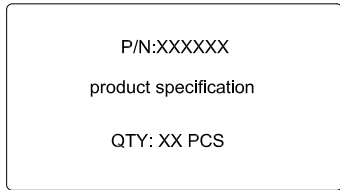

70×38mm

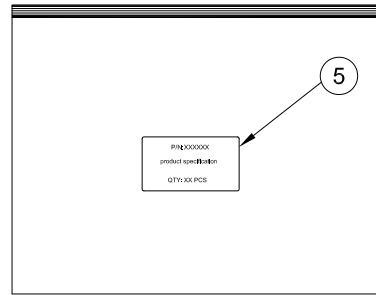

6

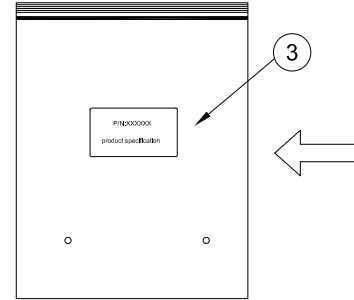

4

Test report:

MPO/PC/MPO/PC/OM3/12F/LM		No. XXXXXXXXXXXX		
Connector	MPO/PC	MPO/PC	MPO/PC	MPO/PC
No.	Ins.loss(dB)	Ret.loss(dB)	Ins.loss(dB)	Ret.loss(dB)
1				
2				
3				
4				
5				
6				
7				
8				
9				
10				
11				
12				
Test Date:		QC PASS:		

2



1

Carton front label template:

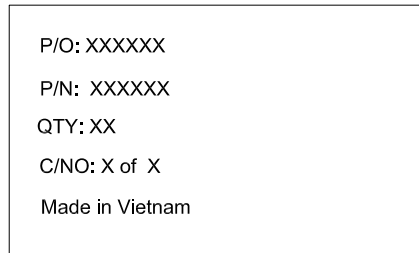

P/O: This number corresponds to the last 7 digits of the Shipping mark on the order
 PN: Take only the last 6 digits of the material number (if there is a color code, it needs to be followed)
 QTY: product quantity
 C/NO: Packing number

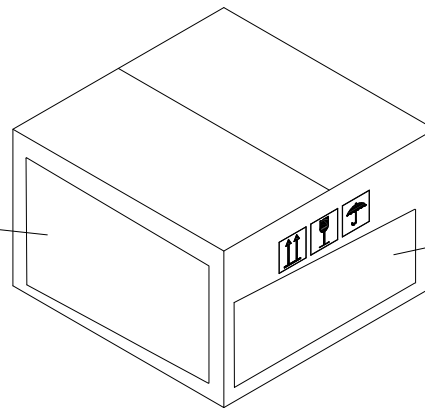

Size: 420×420×270mm

Carton side label template:

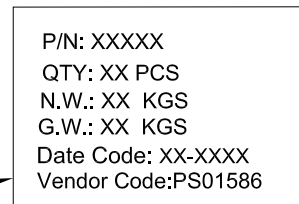

P/N: Take only the last 6 digits of the material number (if there is a color code, it needs to be followed)
 QTY: The quantity of products
 N.W.: The net weight
 G.W.: The gross weight
 Date Code: 35 to 2023 is used as an example. 35 represents the number of weeks finished and 2023 represents the year;
 Vendor Code: The value is fixed to PS01586

Note:

1. Cancel ⑥ large zip-lock bag if the Patchcord length is longer than 20 meters.
2. The ② test documents: put it in a ④ small zip-lock bag.
3. ③ Small zipper bag label: attached to the middle of the ④ small zipper bag.
4. The ⑤ large zip-lock bag label: attached in the middle of the ⑥ large zip-lock bag.

DRAWN F.SUN		CHKD Dylan Chen		APROVED Dylan Chen
SCALE —	UNIT mm	QTY 1 PCS	PAGE 2 OF 3	THIRD ANGLE PROJECTION

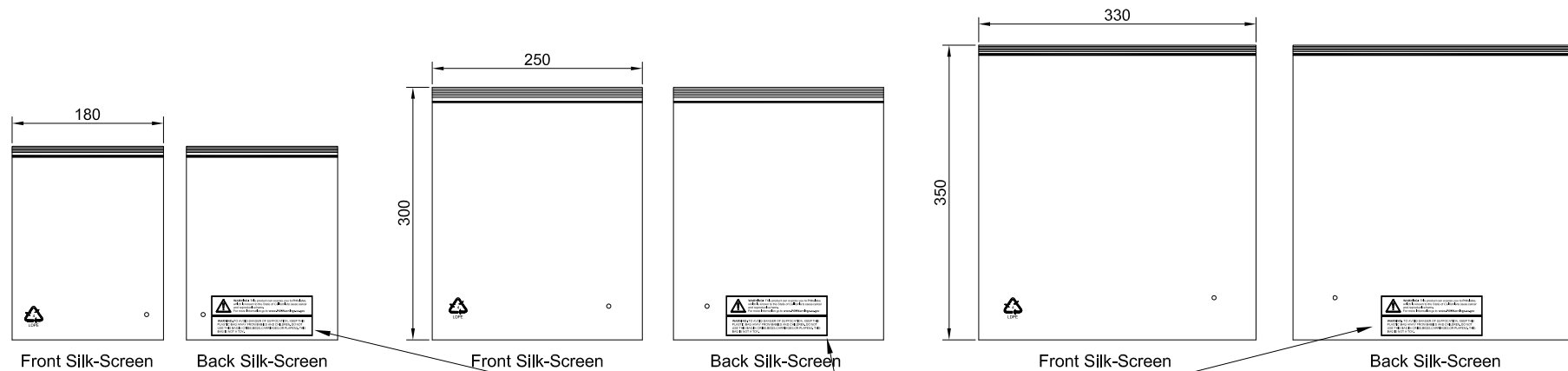

small zip-lock bag have P65 Warning words and prevent choking in children Warning words Silk-Screen

Small zipper lock bag option:
L≤5M: 180×230mm;



WARNING: This product can expose you to Phthalates, which is known to the State of California to cause cancer and reproductive harm. For more information go to www.P65Warnings.ca.gov

WARNING: TO AVOID DANGER OF SUFFOCATION, KEEP THIS PLASTIC BAG AWAY FROM BABIES AND CHILDREN. DO NOT USE THIS BAG IN CRIBS, BEDS, CARRIAGES, OR PLAPENS. THIS BAG IS NOT A TOY.

DRAWN F.SUN		CHKD Dylan Chen		APROVED Dylan Chen
SCALE ---	UNIT mm	QTY 1 PCS	PAGE 3 OF 3	THIRD ANGLE PROJECTION