

NOTE: ALL MATERIAL COMPLIANT ROHS STANDARD

REVISION INFORMATION			
Rev.	Rev. Date	Modified By	Brief Description

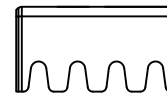
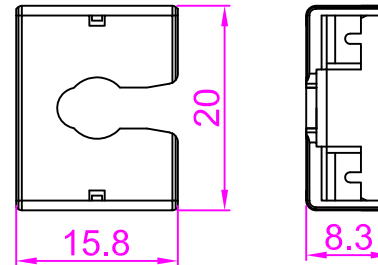
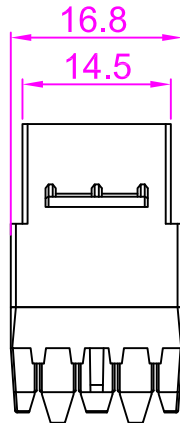
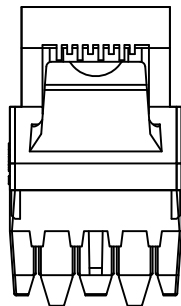
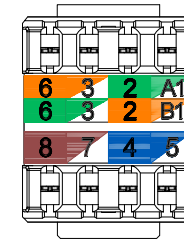
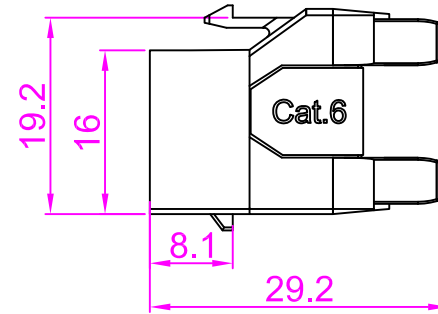
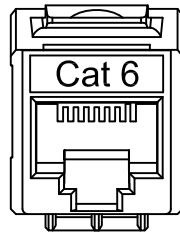
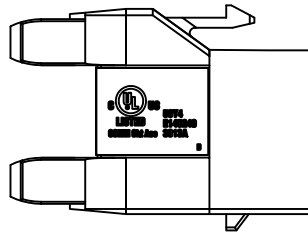

IDC CAP

Part Number	COLOUR	QTY	G.W(LBS)	G.W(KGS)	
1	101701BK	PANTONE 433C	1000	24.3	11
2	101701BL	PANTONE 3015C	1000	24.3	11
3	101701GN	PANTONE 7726C	1000	24.3	11
4	101701GY	PANTONE C001Gray4c	1000	24.3	11
5	101701IV	PANTONE 7501C	1000	24.3	11
6	101701OR	PANTONE 2023C	1000	24.3	11
7	101701RD	PANTONE 1925C	1000	24.3	11
8	101701WT	RAL 9016	1000	24.3	11
9	101701YW	PANTONE 1225C	1000	24.3	11

MATERIAL

KEYSTONE JACK HOUSING: PC HIGH-IMPACT UL94V-0 THERMOPLASTIC.
 SPRING PIN: PHOSPHOR BRONZE C5210-EH, T=0.3mm.
 PLATING: NICKEL UNDERCOAT,
 BESIDES PLATING 50U" GOLD OVER THE PLATED SURFACE ON CONTACT AREA.
 IDC HOUSING: PC HIGH-IMPACT UL94V-0 THERMOPLASTIC.
 IDC CONTACT: PHOSPHOR BRONZE C5191R-H, T=0.4MM, PLATING 100U" SOFT NICKEL .
 PCB: FR-4

PHYSICAL CHARACTERISTICS

INSERTION LIFE: 750 MATING CYCLES WITH FCC COMPLIANT 8P PLUG.
 CONTACT FORCE: 100 GRAMS WITH FCC COMPLIANT 8P PLUG.
 PLUG RETENTION FORCE: 11 LBF MIN.
 DURABILITY: 200 TERMINATION CYCLES.
 CONTACT COMPATIBILITY: ACCOMMODATES 22 TO 24 AWG SOLID.
 OPERATING TEMPERATURE RANGE: -10°C TO 60°C.
 STORAGE TEMPERATURE RANGE: -40°C TO 68°C.
 HUMIDITY: 10%~90% RH.

ELECTRICAL

INSULATION RESISTANCE: 500 M Ω.
 DIELECTRIC WITHSTANDING VOLTAGE: 1000V AC.
 DC CURRENT RATING: 1.5 Amps .
 DC RESISTANCE: 0.1 Ω.
 CONTACT RESISTANCE: 20mΩ.

ACCORDING TO ANSI/TIA-568-C.2
 REQUIREMENTS
 C6 CHANNEL COMPLIANT

Cat 6

56Y4
 E145249



COMMUNICATION
 CIRCUIT ACCESSORIES

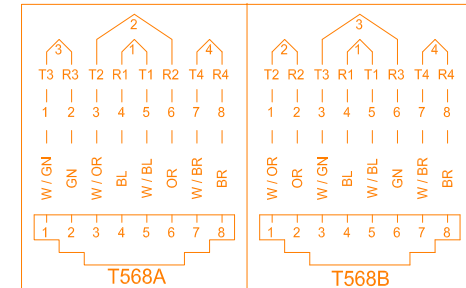

NO.	PART NAME	SPECIFICATION DESCRIPTION	QTY	UNIT
③				
②				
①	IDC Cap	20*15.8*8.3mm	1	PCS

Unless specified on the drawing, tolerances are per the follows:
 .x +1
 .xx +0.2
 .xxx +0.05

DRAWN BY WJH	DATE: 2018-5-3	DESCRIPTION: Cat.6 RJ45 110 Type 180° Keystone Jack
CHECKED BY	SHEET 1 of 1	ITEM NO. 101701XX <small>xx means color</small>
APPROVED BY	SCALE 4:3	REV. 00 UNIT: mm

NOTE: ALL MATERIAL COMPLIANT ROHS STANDARD

REVISION INFORMATION			
Rev.	Rev. Date	Modified By	Brief Description

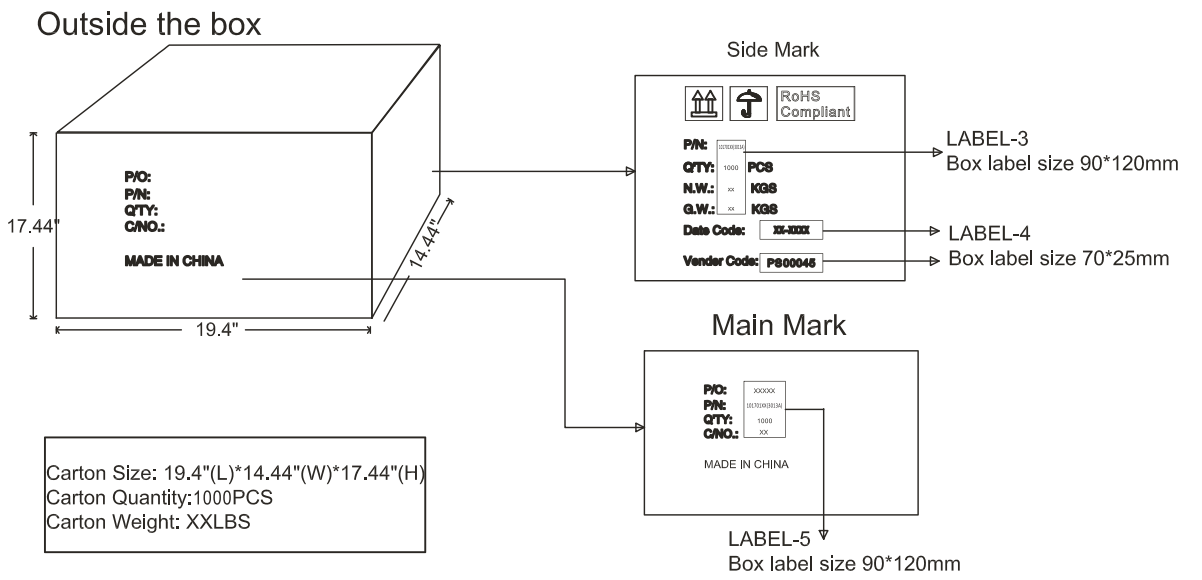
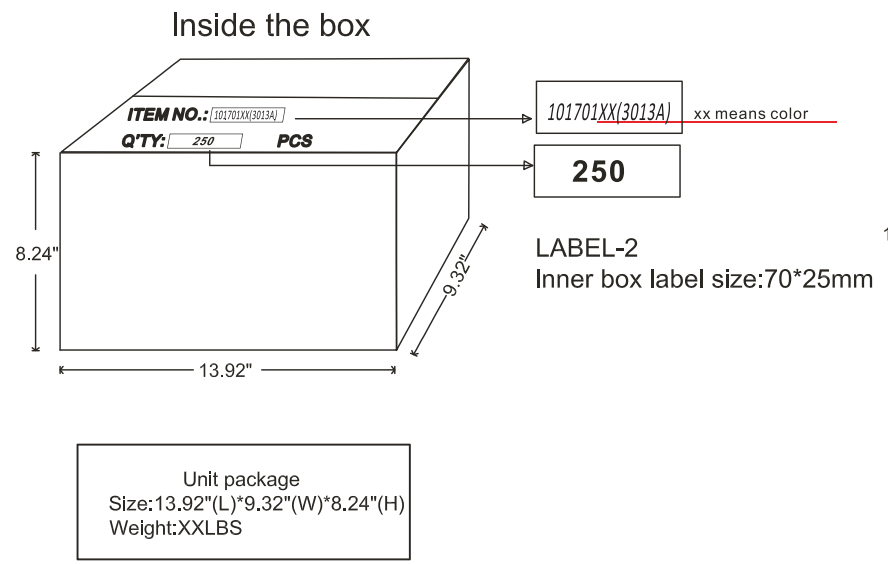
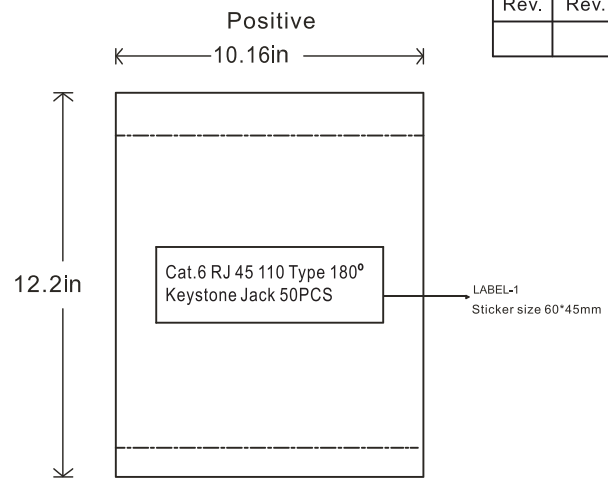
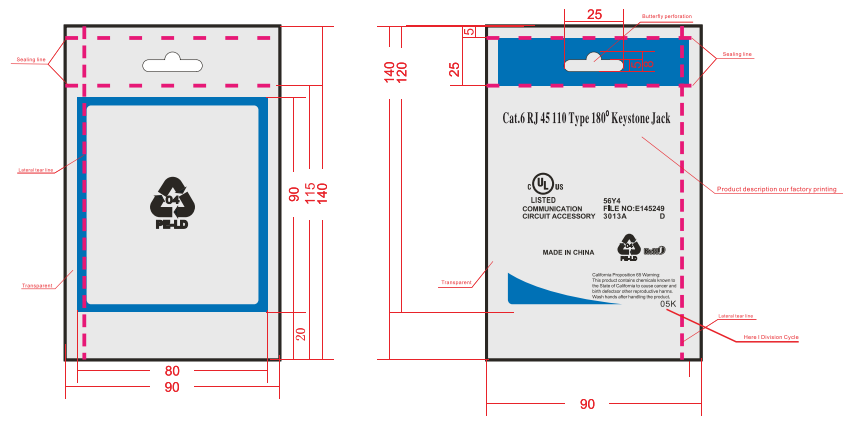

NO.	PART NAME	SPECIFICATION DESCRIPTION	QTY	UNIT
③				
②				
①				

Unless specified on the drawing, tolerances are per the follows:
 .x +1
 .x +0.2
 .xx +0.05

DRAWN BY	DATE: 2018-5-3	DESCRIPTION: Cat.6 RJ 45 110 Type 180° Keystone Jack
CHECKED BY	SHEET 1 of 2	ITEM NO. 101701XX <small>xx means color</small>
APPROVED BY	SCALE 1: 1	REV. 00 UNIT: mm