

NOTE:ALL MATERIAL COMPLIANT ROHS STANDARD

REVISION INFORMATION

Rev.	Rev. Date	Modified By	Brief Description
1.0	2016/04/28	Pillar	Add labels on packaging
2.0	2017/08/21	Ndq	Add one bag to the packing

Electrical character:

- 1)100% Open/short/Intermittent testing
- 2)Withstanding voltage:DC/AC 300V AT 10ms.
- 3)Insulation resistance:10M Ohm(min)
- 4)Conductive resistance:3 Ohm

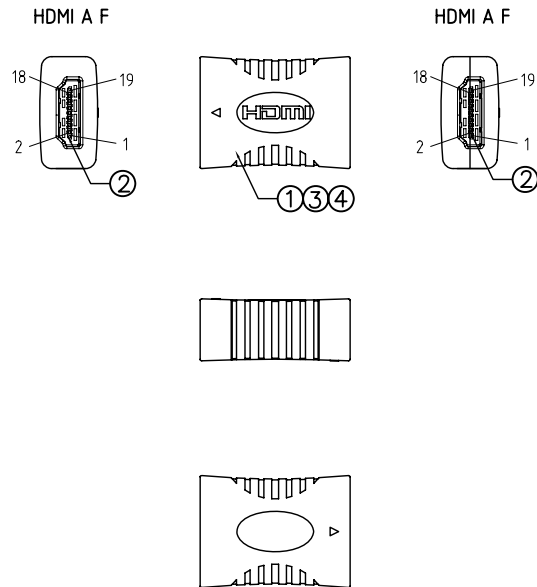

PIN ASSIGNMENT

P1	P2	P1	P2
1	1	11	11
2	2	12	12
3	3	13	13
4	4	14	14
5	5	15	15
6	6	16	16
7	7	17	17
8	8	18	18
9	9	19	19
10	10	Shell	Shell

NO.	PART NAME	SPECIFICATION DESCRIPTION	QTY	UNIT
①	PCBA	HDMI A Female to Female PCBA		
②	Conn	HDMI A Female,Pin G/F,Black Insulation,Shell/Steel(Gold Plated)		
③	Innrmold	PE,Low density		
④	Overmold	PVC,45Pa,Black		

Unless specified on the drawing, tolerances are per the follows:

.	+1
.x	+0.2
.xx	+0.05

DRAWN BY	DATE: 2017/08/21	DESCRIPTION: HDMI Male-Female 90 degree Adapter
CHECKED BY	SHEET 1 of 2	ITEM NO. 181242
APPROVED BY	SCALE None	REV. 2.0 UNIT:mm

NOTE: CARTON MATERIAL MUST BE A=A

REVISION INFORMATION

Rev.	Rev. Date	Modified By	Brief Description
1.0	2016/04/28	Pillar	Add labels on packaging
2.0	2017/08/21	Ndq	Add one bag to the packing

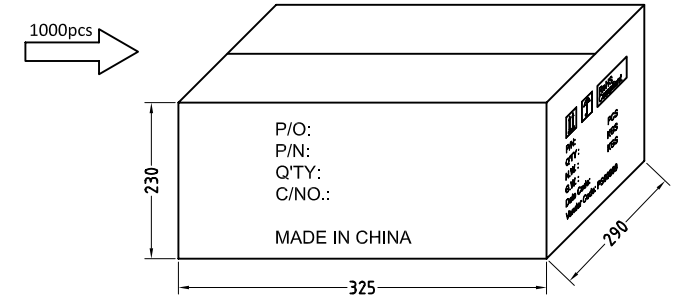
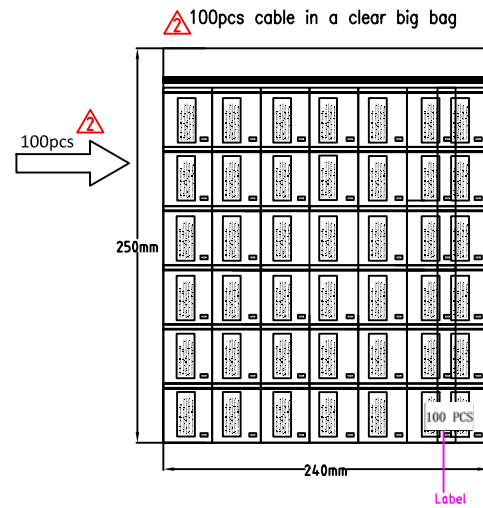
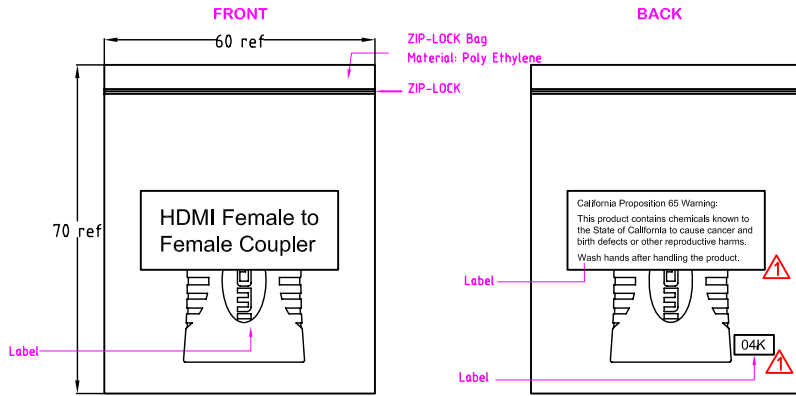

MAIN MARK

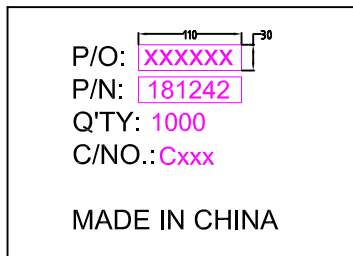

SIDE MARK

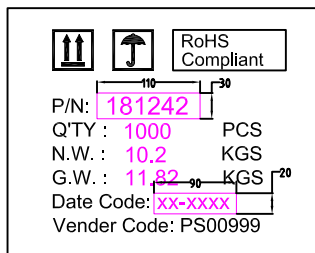

Label
Size: 50*20mm

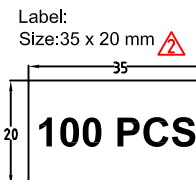
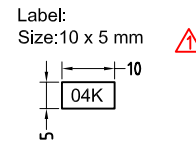
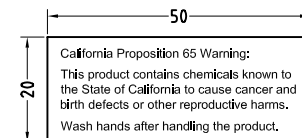
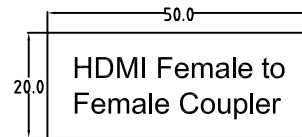

Carton Size: 12.80"(L)*11.42"(W)*9.06"(H)
Carton Quantity: 1000 pcs
Carton Weight: 26.60 LBS

Packing Instruction:

1. Each product in a POLY-BAG, The label is attached to the PE bag. 100pcs cable in a clear big bag, The label is attached to the PE bag,
2. Use a waterproof bag to pack the products before going into master carton. Make sure each individual cable is staggered and positioned tidily. A paperboard is needed in both the bottom and the top of the products.
3. See shipping mark on the left.



DRAWN BY	DATE: 2017/08/21	DESCRIPTION: HDMI Male-Female 90 degree Adapter
CHECKED BY	SHEET 2 of 2	ITEM NO. 181242
APPROVED BY	SCALE None	REV. 2.0 UNIT:mm