

NOTE: ALL MATERIAL COMPLIANT ROHS STANDARD

REVISION INFORMATION			
Rev.	Rev. Date	Modified By	Brief Description

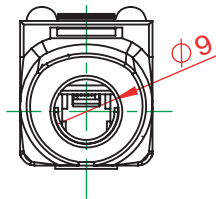
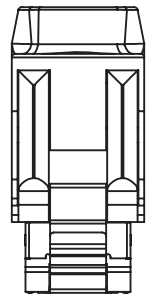
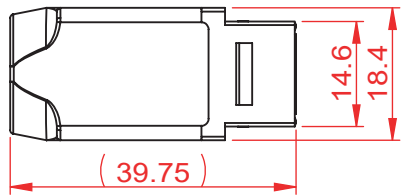

REAR VIEW

SUGGESTED MOUNTING CUTOUT

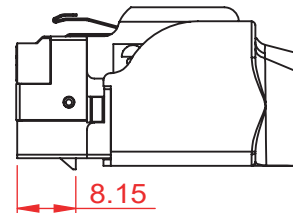
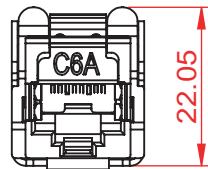
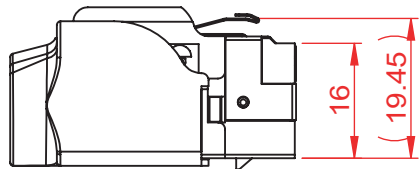
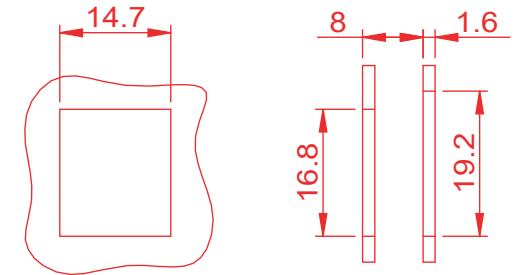

ACCORDING TO : ANSI/TIA-568-C.2  
ISO/IEC 11801 2nd Edition  
IEC 60603-7



ETL Verified Channel to ANSI/TIA-568-B.2-10 Category 6A Tested for all transmission parameters also including PSANEXT and PSAACRF Measurements Certificate no : 3154740CRT-004d

Color	PANTONE
Black	PANTONE 426C
Blue	PANTONE 285C
Red	PANTONE 1805C
Green	PANTONE 341C
Orange	PANTONE 2024C
Yellow	PANTONE 120C
Ivory	PANTONE 4535C
Gray	PANTONE 420C
Purple	PANTONE 2613C

MATERIAL

BRACKET : STAINLESS.  
KEYSTONE JACK HOUSING : ZINC ALLOY,NICKEL PLATED.  
SPRING WIRE : PHOSPHOR BRONZE,50U" GOLD PLATED.  
CONTACT HOLDER : ABS,UL94V-0.  
IDC PLASTIC : PC,UL94V-0.  
IDC CONTACT : PHOSPHOR BRONZE ,TIN OVER NICKEL UNDERCOAT.

PHYSICAL CHARACTERISTICS

SUITABLE IMPACT TOOL : 110 STYLE PUNCH DOWN TOOL.  
INSERTION LIFE : 750 MATING CYCLES WITH FCC COMPLIANT 8P PLUG.  
CONTACT FORCE : 100 GRAMS WITH FCC COMPLIANT 8P PLUG.  
PLUG RETENTION FORCE : 11 LBF MIN.  
DURABILITY : 200 TERMINATION CYCLES.  
CONTACT COMPATIBILITY : ACCOMMODATES 22 TO 24 AWG SOLID.  
OPERATING TEMPERATURE RANGE : -10°C TO 60°C.  
STORAGE TEMPERATURE RANGE : -40°C TO 68°C.  
HUMIDITY : 10%~90%RH.

ELECTRICAL

INSULATION RESISTANCE : 500 MΩ.  
DIELECTRIC WITHSTANDING VOLTAGE : 1000 V AC.  
DC CURRENT RATING : 1.5 Amps.  
DC RESISTANCE : 0.1Ω.  
CONTACT RESISTANCE : 20mΩ.

NOTE

- WILL NOT SUPPORT CHANNEL SHORTER THAN 15M.
- ONLY ACCEPT RJ-45 8P8C PLUG.

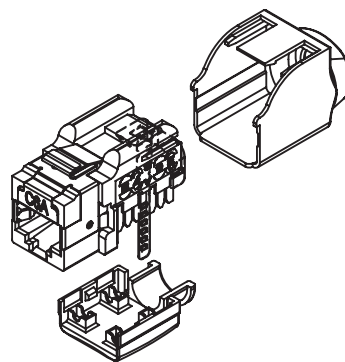

Cat 6A

56Y4  
E145249



LISTED  
COMMUNICATION  
CIRCUIT ACCESSORIES

ENCLOSURE

IDC CAP X 1 PC  
CASTING COVER X 1 PC

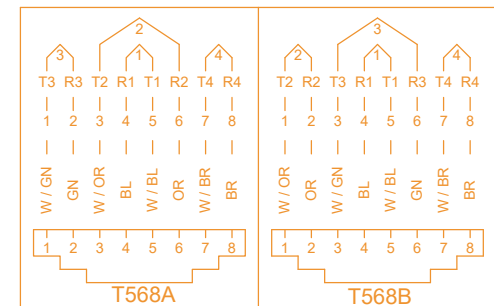

NO.	PART NAME	SPECIFICATION DESCRIPTION	QT'Y	UNIT
③				
②				
①				

Unless specified on the drawing,tolerances are per the follows:  
.x +1  
.x +0.2  
.xx +0.05

DRAWN BY	DATE: 2019/7/10	DESCRIPTION: Cat.6A STP 90 degree Keystone Jack
CHECKED BY	SHEET 1of1	ITEM NO. 101724
APPROVED BY	SCALE NONE	REV. 00 UNIT:mm