

NOTE:ALL MATERIAL COMPLIANT ROHS STANDARD

11\*1461\*\*\*\*

REVISION INFORMATION

Rev.	Rev. Date	Modified By	Brief Description

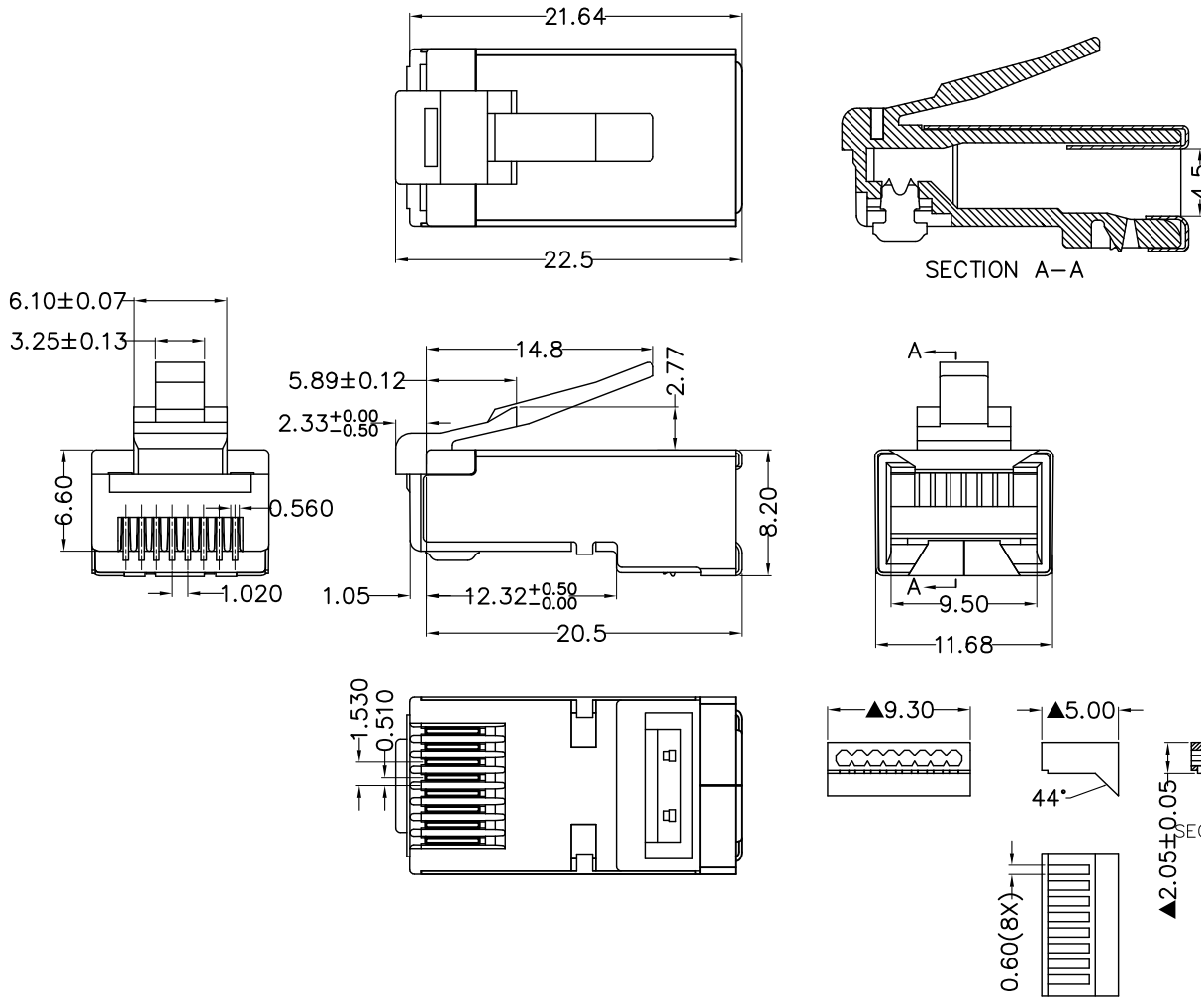

NOTES:

- 1.Operation Temperature:-40℃~+85℃.
- 2.Electrical Characteristics:
  - 2.1>Rated Current:125V AC,1.5A@25℃.
  - 2.2>Contact Resistance:20mΩ Max.
  - 2.3>Insulation Resistance:500MΩ Min,100V DC/min.
  - 2.4>Voltage Proof: 1000V AC/1 minute no breakdown.
- 3.Mechanical Characteristics:
  - 3.1>Insertion Force & Withdrawal Force:30N Max.
  - 3.2>Durability:750 cycles Min.
- 4.Environmental compliance:
  - 4.1>the products are compliant with the RoHS, and REACH etc.
- 5.CONDUCTOR:STRANDED&SOLID WIRE,23AWG,24AWG.  
(It can be used for the wire OD fromØ0.96~Ø1.02mm.)

NO	NAME	QTY	PART NO.	DESCRIPTION	MATERIAL
3	Load Bar	1PCS	30*0401**	Load Bar,Single Row Ø1.00mm	Transparent PC
2	Line Frame	1PCS	31*0000**	Line Frame One-piece	Transparent PC
1	Modular Plug	Shell	1PCS	Square hole	Au: G/F" <input type="checkbox"/> 1u" <input type="checkbox"/> 3u" <input type="checkbox"/> Ni:80u" <input checked="" type="checkbox"/>
		Contacts	8PCS	2Prongs <input checked="" type="checkbox"/> 3Prongs <input type="checkbox"/>	G/F" <input type="checkbox"/> 1u" <input type="checkbox"/> 3u" <input type="checkbox"/> 6u" <input type="checkbox"/> 15u" <input type="checkbox"/> 30u" <input type="checkbox"/> 50u" <input checked="" type="checkbox"/> OTHER <input type="checkbox"/>
		Housing	1PCS	21*1461**	CAT6A/FTP HOUSING/LONG BODY/SINGLE ROW
					Brass <input checked="" type="checkbox"/> Spcc <input type="checkbox"/> Brass <input type="checkbox"/> <input checked="" type="checkbox"/> Phosphor copper <input type="checkbox"/>
					ANGLE ±2°

DRAWN BY	DATE 2024.04.27	DESCRIPTION: RJ45 Cat.6A Shielded Plug Stranded 50 Micron 2prong 3pc type 100pk
CHECKED BY	SHEET 1 of 3	ITEM NO:101233
APPROVED BY	SCALE 1:1	REV:01    UNIT:mm

DIMENSIONAL TOLERANCE	
X.X	±0.20
X.XX	±0.10
X.XXX	±0.05

Polybag size: 130\*190\*0.06mm

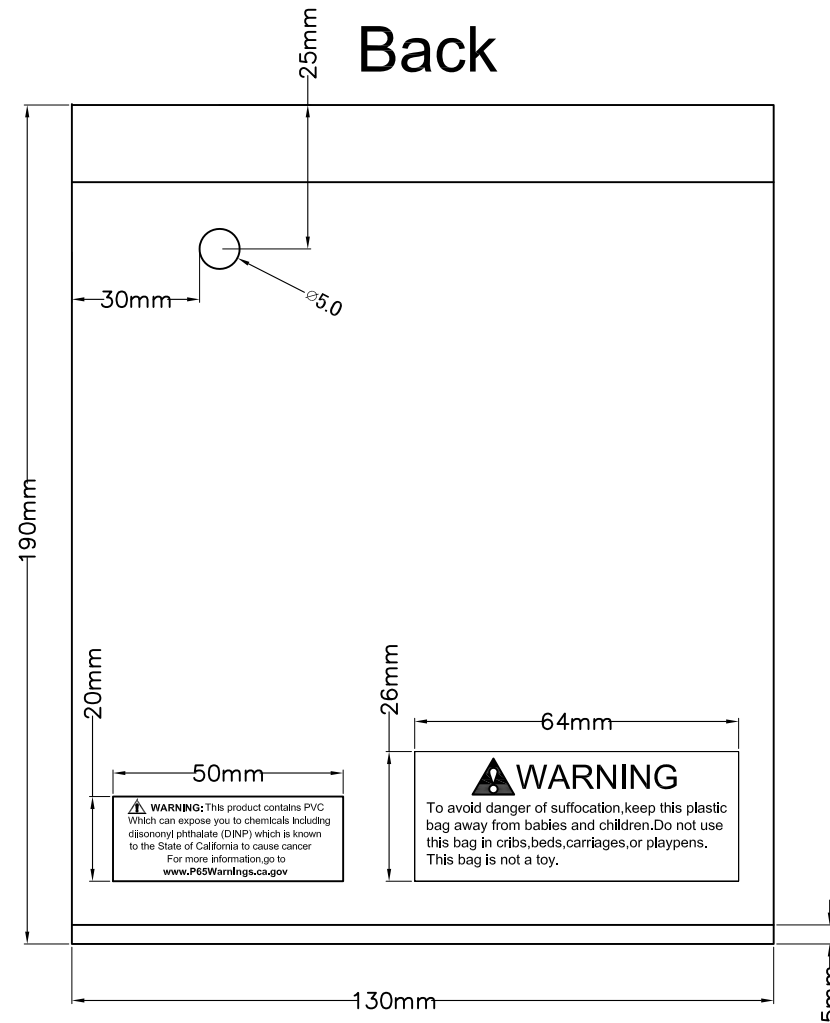
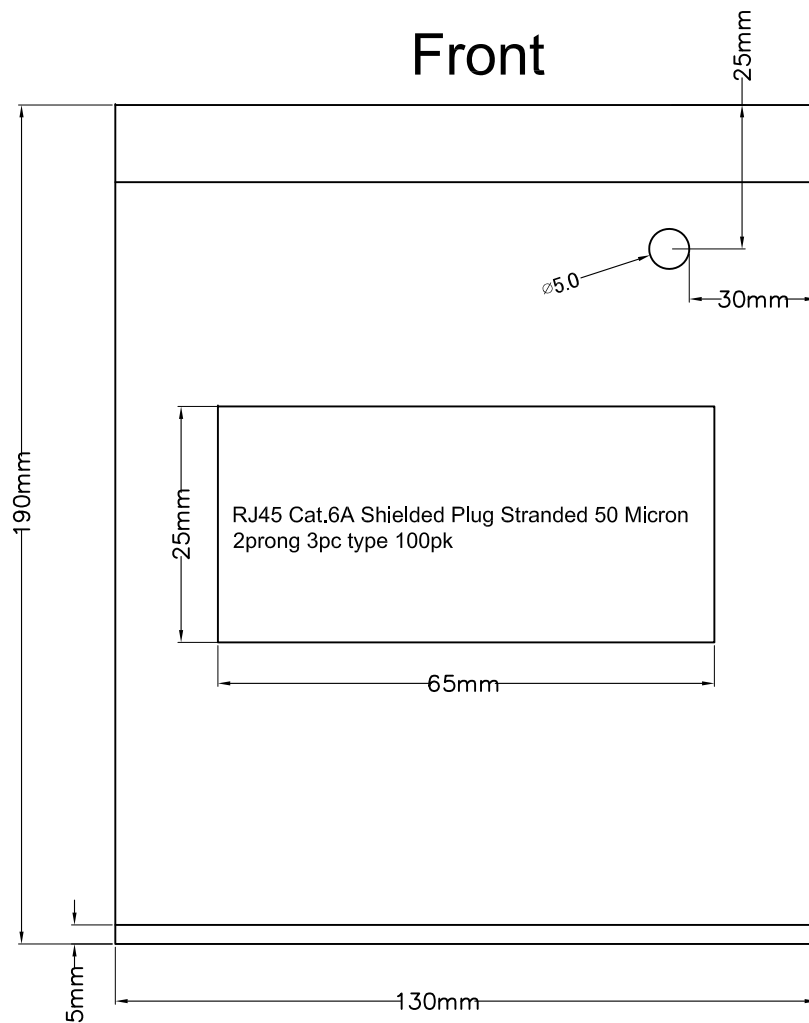

DRAWN BY	DATE 2024.04.27	DESCRIPTION: RJ45 Cat.6A Shielded Plug Stranded 50 Micron 2prong 3pc type 100pk		
CHECKED BY	SHEET 2 of 3	ITEM NO:101233		
APPROVED BY	SCALE 1:1	REV:01	UNIT:mm	

NOTE:ALL MATERIAL COMPLIANT ROHS STANDARD

REVISION INFORMATION



Rev.	Rev. Date	Modified By	Brief Description

Main Mark

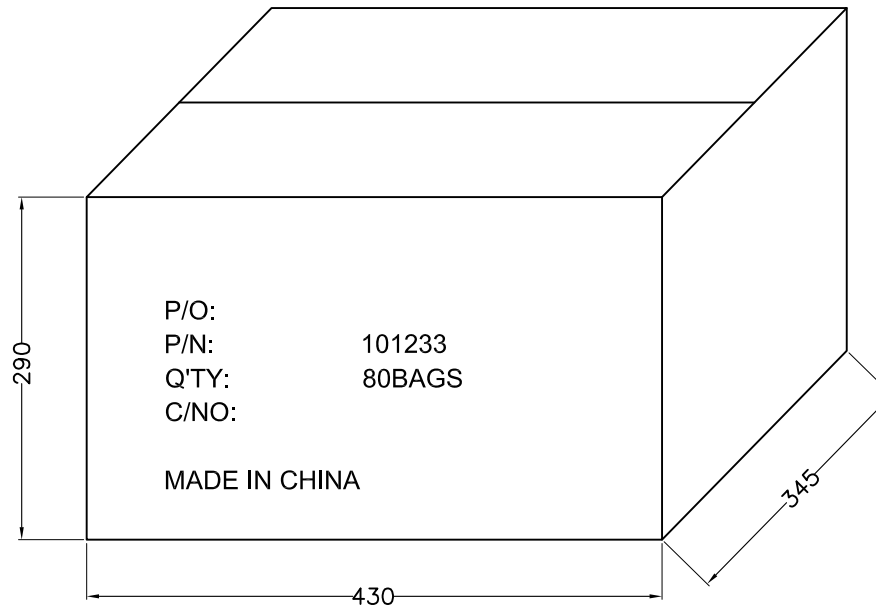
P/O:  
P/N: 101233  
Q'TY: 80BAGS  
C/NO:  
  
MADE IN CHINA



Side Mark

	P/N:	101233
	Q'TY:	80BAGS
	N.W:	KGS
	G.W:	KGS
	Date Code:	
	Vender Code:	

Carton Size: 430x345x290MM  
Carton Quantity: 80BAGS

100PCS/PE BAG

80BAGS/CARTON



DRAWN BY	DATE 2024.04.27	DESCRIPTION: RJ45 Cat.6A Shielded Plug Stranded 50 Micron 2prong 3pc type 100pk		
CHECKED BY	SHEET 3 of 3	ITEM NO:101233		
APPROVED BY	SCALE 1:1	REV:01	UNIT:mm	