

NOTE:ALL MATERIAL COMPLIANT ROHS STANDARD

11\*1268\*\*\*\*

REVISION INFORMATION

Rev.	Rev. Date	Modified By	Brief Description
00	2020.06.12	JING_LI	First ISSUE
01	2024.05.09	JING_LI	Change SPEC.

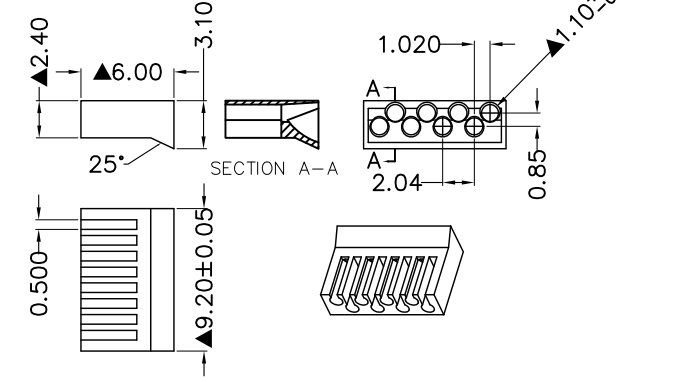
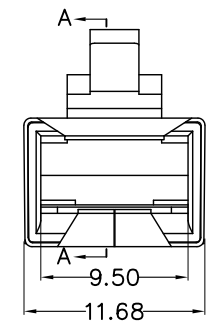
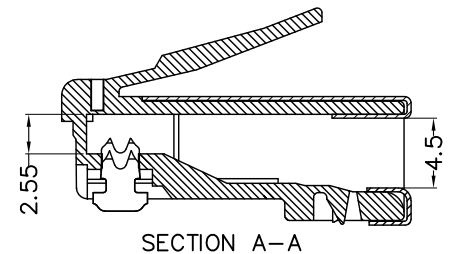
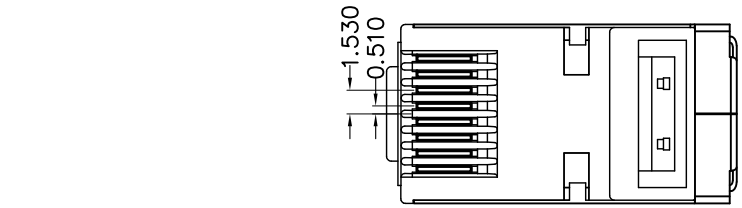
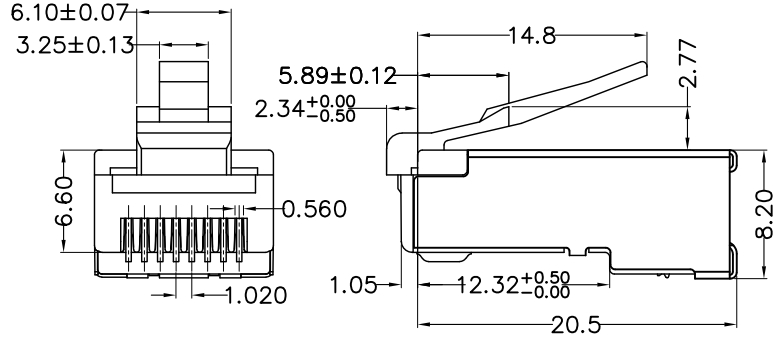
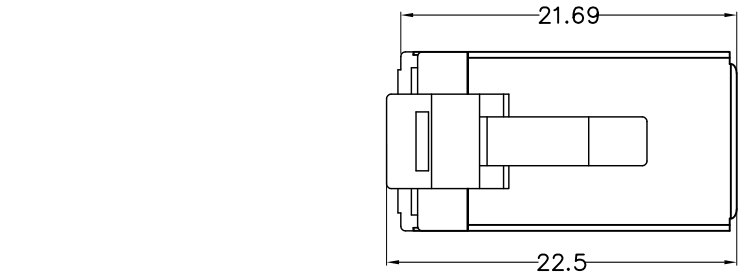

NOTES:

- 1.Operation Temperature:-40℃~+85℃.
- 2.Electrial Characteristics:
  - 2.1>Rated Current:125V AC,1.5A@25℃.
  - 2.2>Contact Resistance:20mΩ Max.
  - 2.3>Insulation Resistance:500MΩ Min,100V DC/min.
  - 2.4>Voltage Proof: 1000V AC/1 minute no breakdown.
- 3.Mechanical Characteristics:
  - 3.1>Insertion Force & Withdrawal Force:30N Max.
  - 3.2>Durability:750 cycles Min.
- 4.Environmental compliance:
  - 4.1>the products are compliant with the RoHS, and REACH etc.
- 5.CONDUCTOR:STRANDED&SOLID WIRE,23AWG,24AWG.  
(It can be used for the wire OD fromØ1.00~Ø1.10mm.)

NO	NAME	QTY	PART NO.	DESCRIPTION	MATERIAL	
2	Load Bar	1PCS	30*0144**	Load Bar,4Up and 4Down Ø1.10mm	Transparent PC	
1	Modular Plug	Shell	1PCS	43*20**09	Square hole Au: G/F" <input type="checkbox"/> 1u" <input type="checkbox"/> 3u" <input type="checkbox"/> Ni:80u" <input checked="" type="checkbox"/>	Brass <input checked="" type="checkbox"/> Spcc <input type="checkbox"/>
		Contacts	8PCS	/	2Prongs <input checked="" type="checkbox"/> 3Prongs <input type="checkbox"/>	Brass <input checked="" type="checkbox"/> Phosphor copper <input type="checkbox"/>
		Housng	1PCS	21*1268**	CAT6/FTP HOUSING/LONG BODY/4UP AND 4DOWN	94V-2 <input checked="" type="checkbox"/> 94V-0 <input type="checkbox"/>
					ANGLE ±2°	

DRAWN BY	DATE 2024.05.09	DESCRIPTION: RJ45 Cat.6 Shielded Plug Stranded 50 Micron 2prong w/Insener 100pk
CHECKED BY	SHEET 1 of 3	ITEM NO:101229
APPROVED BY	SCALE 1:1	REV:01
	UNIT:mm	

Polybag size: 130\*190\*0.06mm

Rev.	Rev. Date	Modified By	Brief Description
00	2020.06.12	JING_LI	First ISSUE
01	2024.05.09	JING_LI	Change SPEC.

Front

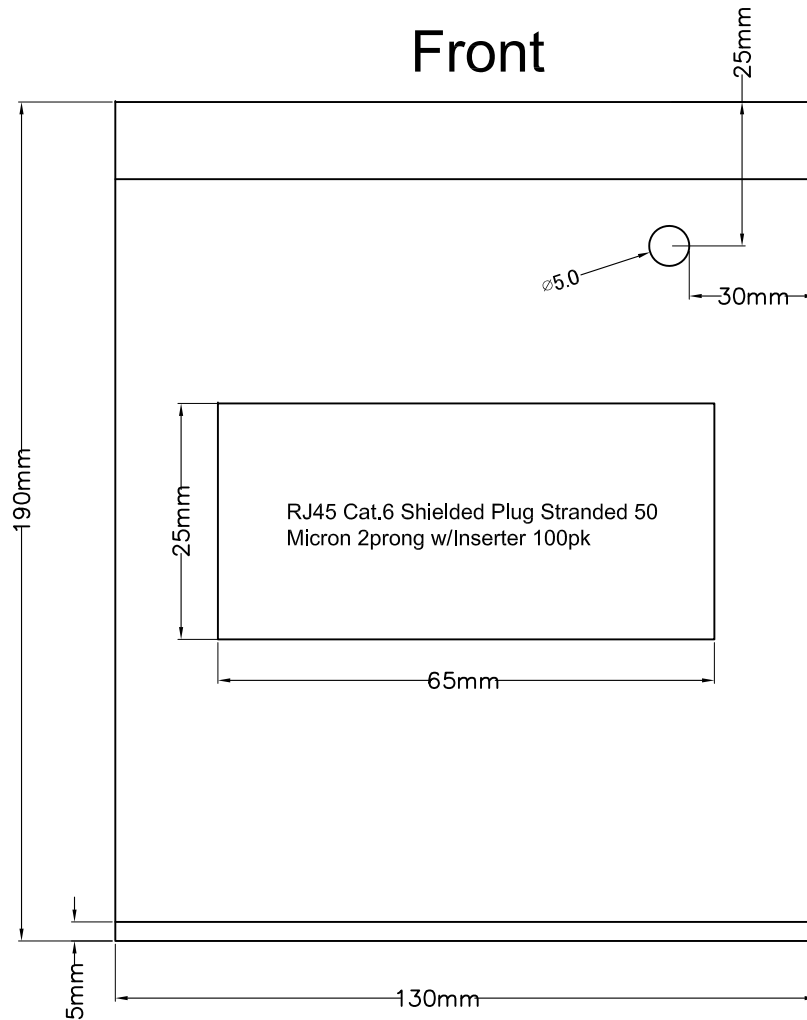

Back

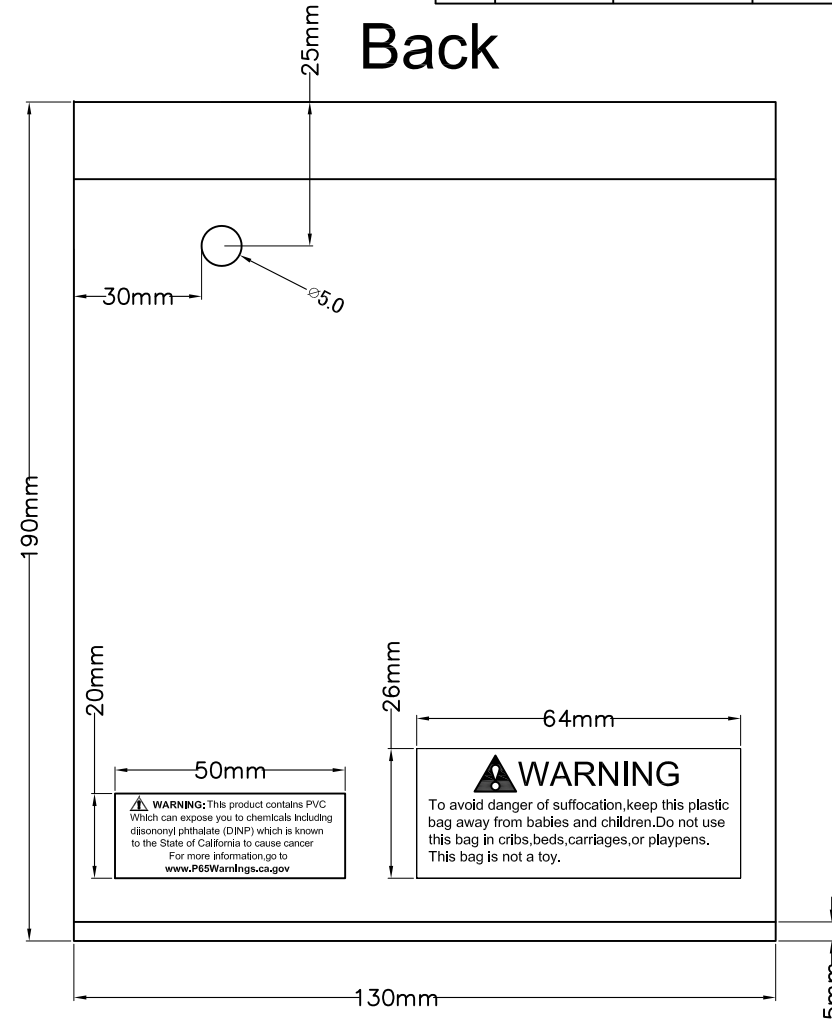

DRAWN BY	DATE 2024.05.09	DESCRIPTION: RJ45 Cat.6 Shielded Plug Stranded 50 Micron 2prong w/Inserter 100pk		
CHECKED BY	SHEET 2 of 3	ITEM NO:101229		
APPROVED BY	SCALE 1:1	REV:01	UNIT:mm	

NOTE:ALL MATERIAL COMPLIANT ROHS STANDARD

REVISION INFORMATION

Rev.	Rev. Date	Modified By	Brief Description
00	2020.06.12	JING_LI	First ISSUE
01	2024.05.09	JING_LI	Change SPEC.

Main Mark

P/O:  
P/N: 101229  
Q'TY: 90BAGS  
C/NO:  
  
MADE IN CHINA

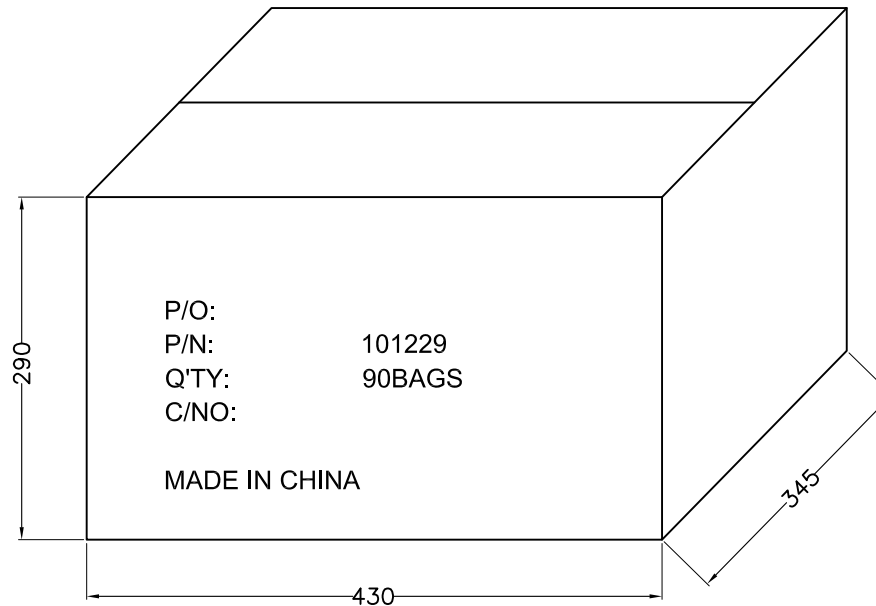

Side Mark

  	P/N:	101229
	Q'TY:	90BAGS
	N.W:	KGS
	G.W:	KGS
	Date Code:	
	Vender Code:	

Carton Size: 430x345x290MM  
Carton Quantity: 90BAGS

100PCS/PE BAG

90BAGS/CARTON



DRAWN BY	DATE 2024.05.09	DESCRIPTION: RJ45 Cat.6 Shielded Plug Stranded 50 Micron 2prong w/Inserter 100pk		
CHECKED BY	SHEET 3 of 3	ITEM NO:101229		
APPROVED BY	SCALE 1:1	REV:01	UNIT:mm	