

LC Fiber Optic Connectors

Termination Procedures for Single-mode and Multimode Fiber Optic Connectors using Epoxy

SECTION **A**

Warnings, Recommendations and Overview

1. Most fibers can be mechanically stripped without the aid of chemicals or heat.
2. The recommended cleaning solvent for connectors and tools is isopropyl alcohol (reagent grade, 99% or better). Do not use acetone for cleaning.
3. The connectors with PC finishes are completely intermateable with flat finished connectors. PC to flat terminations actually provide improved performance over flat to flat terminations. PC to PC terminations as produced while using this manual, however, offer the best performance.
4. Safety glasses should be worn when working with optical fibers.
5. Appropriate containers of clean, dry, compressed air may be obtained from photographic supply stores. Do not use types that leave a residue.

LC SX 2.0mm one piece

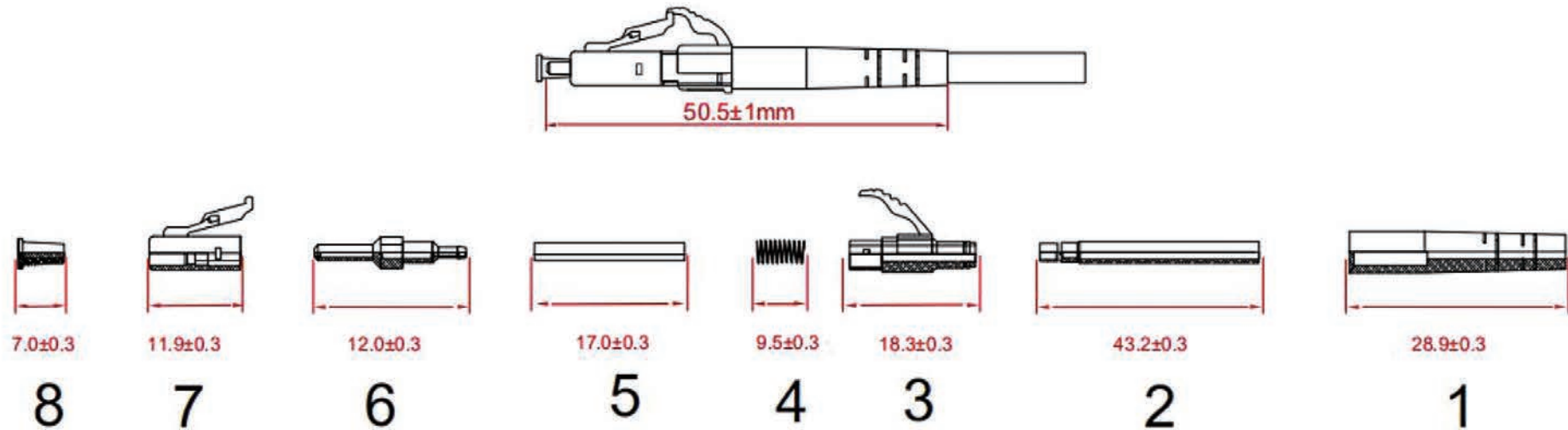

	<i>Name of part</i>	<i>Specification</i>	<i>Quantity</i>
1	Boot	28.9mm	1
2	Raychem	43.2mm	1
3	Stopper	18.3mm	1
4	Spring	9.5mm	1
5	Plastic Tube	17.0mm	1
6	Ferrule	12.0mm	1
7	Housing	11.9mm	1
8	Dust Cup	7.0mm	1

NOTE:

1. Fiber Optic Connector Standard Type LC of IEC61754-20
2. LC Specification Operating Temperature: -40 °C to 85 °C
3. Compliance All Material Compliance With UL 94V0

SECTION B This section is for mounting LC connectors on 2.0 mm cable.

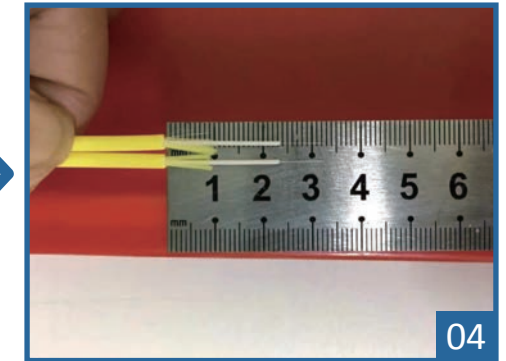
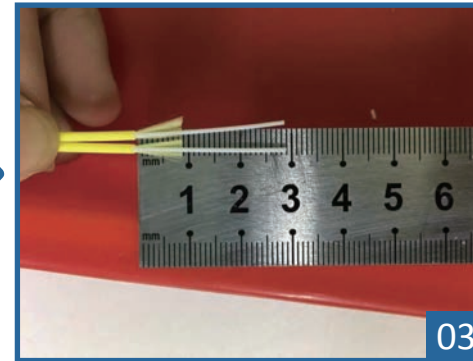
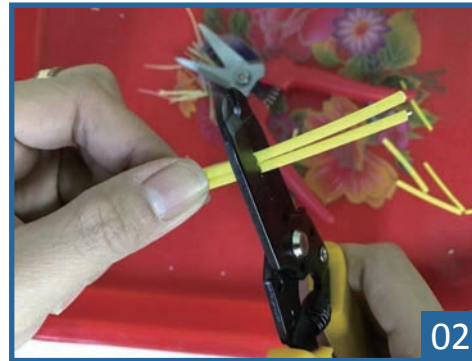
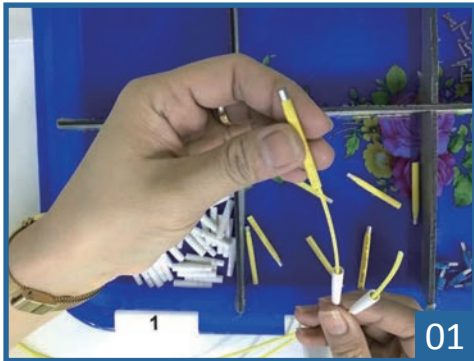

1. SLIP BOOT, HEAT SHRINK TUBE WITH CRIMP RING, ONTO THE CABLE DO NOT FORGET TO DO THIS STEP.

2. CUT AND REMOVE 29 mm OF THE CABLE'S OUTER JACKET

Adjust the yellow handled stripper to cut the jacket and not the Kevlar. Using the ruler supplied in the field kit, measure and mark the cable 29 mm from the end of the jacket. Close the yellow handled stripper on the cable until the outer jacket is cut.

3. CUT AND FLARE THE STRENGTH MEMBERS

Gather the Kevlar and pull it off to one side giving it a slight twist.

4. BUFFER REMOVAL

With the Fiber stripping plier's arrow pointing in the direction of the stripping, remove the fiber's buffer about 8-9 mm. Be sure to remove the stripped material from the tool after each incremental cut. When stripping the last increment, the end of the stripping collar should gently rest against the fiber guide inside of the clearance hole. This will ensure the correct buffer length.

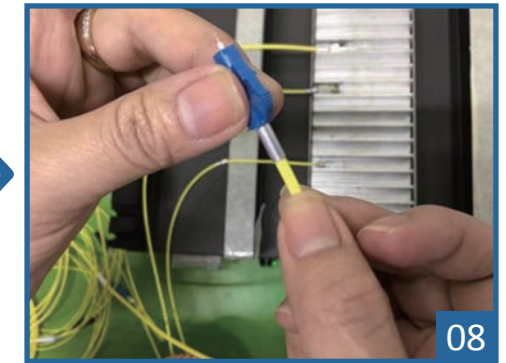
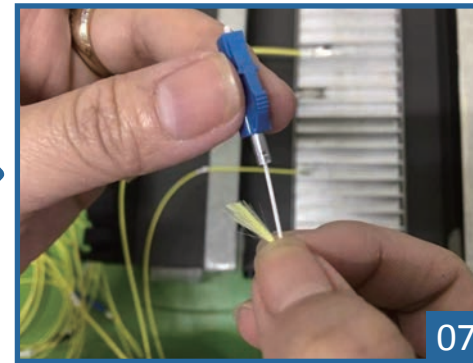
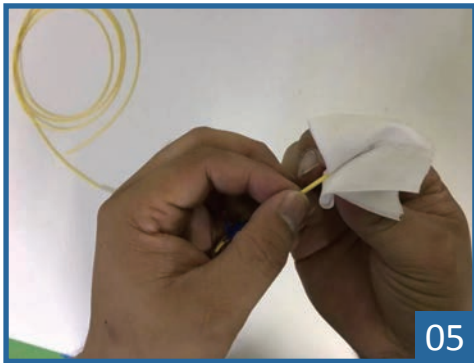

5. CLEAN THE FIBER WITH ALCOHOL 8-9mm

With the collar still in place, moisten a lint free cloth with isopropyl alcohol from the bottle and wipe the fiber clean (Fig. B8). Make sure there is absolutely no buffer residue or dirt on the fiber by holding it to a light and inspecting for a smooth shiny surface. If necessary, wipe the fiber a second time to be sure that it is clean.

6. INJECT EPOXY INTO THE CONNECTOR

Each time you inject a new connector, wipe the needle tip clean to be sure that it is completely free of epoxy.

7. THREAD THE CONNECTOR ONTO THE FIBER

Hold the cable in one hand and hold the connector in the other hand. Rest your hands on the table or against each other and carefully thread the connector straight onto the fiber. Slowly rotate the ferrule between thumb and forefinger in order to ease the funneling of the fiber into the guide hole of the ferrule. Carefully observe that the fiber is moving through the connector. This ensures that the fiber hasn't broken during the mounting process.

8. Install and Secure Heat Shrink Tube with Crimp – Slip the cable (crimp) sleeve over the outer jacket and the connector body to capture the yarn between the body and sleeve.

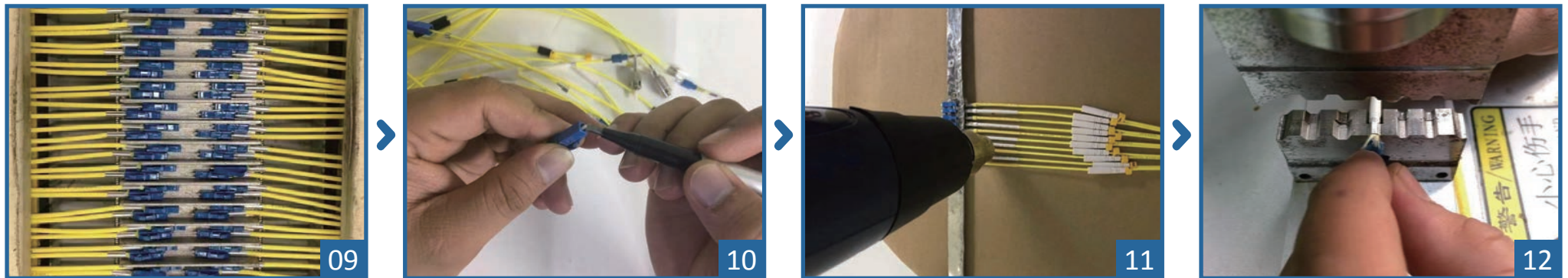

9. When the oven is heated to the proper temperature, the heater light will go off. Place the ferrule into one of the oven's ports. After 20 minutes, remove the connector from the oven and place it in the curing stand to cool.

Note: Do not score the fiber before the epoxy is cool and hard.

10. Score the Fiber—Score the fiber close to the crest of the adhesive bead. Scissors may be used as an optional method of removing the excess fiber.

Note: A clean, short score significantly improves the success rate. Do not break the fiber.

11. Fix Heat Shrink Tube with Hot Air Gun until it is shrank and fixed onto the cable.

12. Secure Crimp Sleeve – For 2.0 mm cable, before crimping, make sure the sleeve is fully seated on the cable retention member. Align the crimp sleeve with the LC cavity of crimping machine.

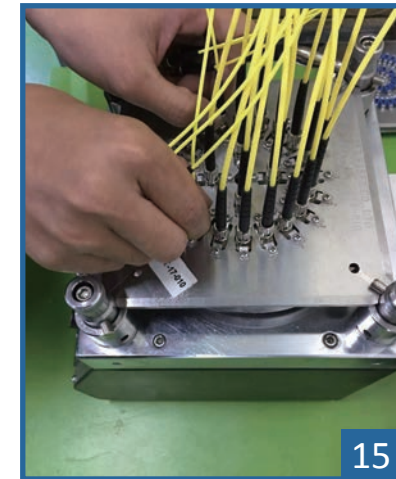
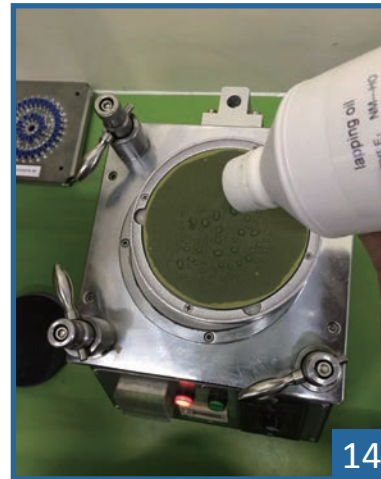
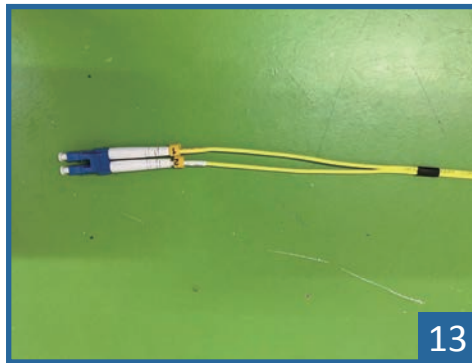

13. Install The Boot with The Connector until it stays well and not loose.

14. PREPARE THE 30 μ m, 9 μ m, 1 μ m and ADS POLISHING SURFACE

Clean the surface of the soft polishing pad with a lint-free cloth dampened with isopropyl alcohol. Blow clean both sides of a sheet of 30 μ m, 9 μ m, 1 μ m lapping acetate. Place the acetate shiny side down onto the soft pad.

Note: Carefully follow safety, health and disposal information on container label or Material Safety Data Sheet for isopropyl alcohol being used.

15. PREPARE THE POLISHING JIG AND CONNECTOR

Wipe the polishing surface of the jig with a lint-free cloth moistened with isopropyl alcohol. Blow the entire jig clean with compressed air. Clean the connector with compressed air only, since wiping it may break the fiber. Insert connector into the jig until they stay well.



16

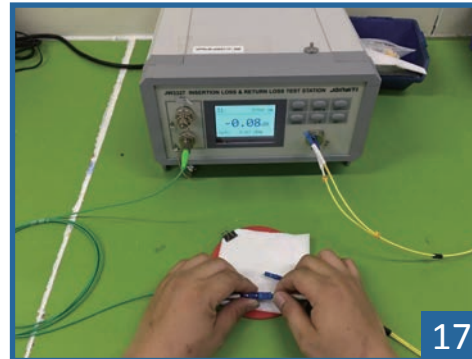

17



18



19

16. FIRST POLISHMENT OF CONNECTOR FERRULE SURFACE BY

THE 30 μ m, 9 μ m and 1 μ m POLISHING FILM Set parameter of polishing machine and polish connector ferrule surface by 30 μ m, 9 μ m and 1 μ m POLISHING FILM

17. INSERTION LOSS CHECK

After polishing, remove the connector from the polishing jig, clean the ferrule and insert it into the Insertion loss to check $IL \leq 0.3db$, please clean ferrule, adapter and calibrate the machine before testing to make sure the value is real.

18. SECOND POLISHMENT OF CONNECTOR FERRULE SURFACE BY THE ADS POLISHING FILM

Set parameter of polishing machine and polish connector ferrule surface by ADS POLISHING FILM

19. MICROSCOPE CHECK

After polishing, remove the connector and insert it into the fiber MICROSCOPE. The fiber should be free of epoxy and scratches and be flush with the domed end of the ceramic ferrule. If scratches or epoxy are present clean the 1 μ m acetate surface and repeat STEP 19 with frequent inspections.