

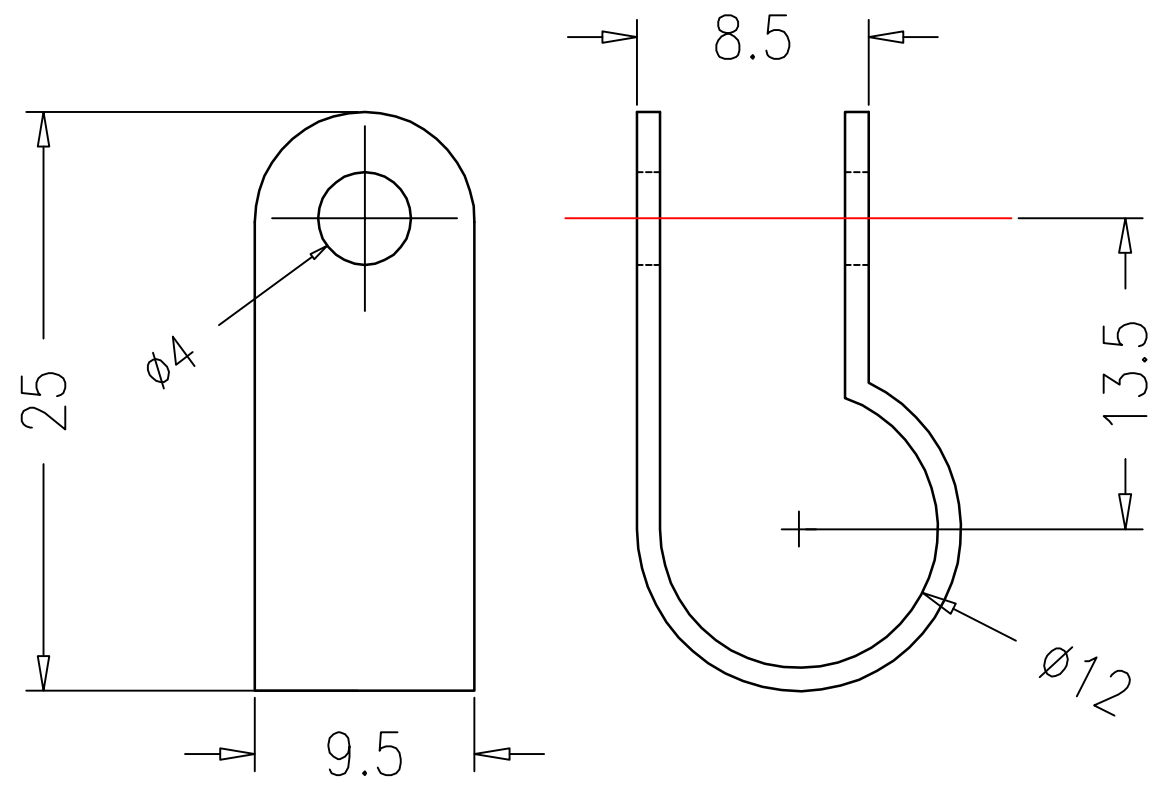

NOTE: ALL MATERIAL COMPLIANT ROHS STANDARD

REVISION INFORMATION		
Rev.Date	Modified By	Brief Description



③				
②				
①	220305CL	R Type Cable Clamp 1/2 " Clear		
NO.	PARTNAME	SPECIFICATION DESCRIPTION	QTY	UNIT

BestLinkNetwork

DRAWN BY	DATE: 2012/7/1	DESCRIPTION: R Type Cable Clamp 1/2 "
CHECKED BY	SHEET 1 of 1	ITEM NO. 1/2R
APPROVED BY	SCALE 1:1	REV. 00    UNIT:mm

