

NOTE: ALL MATERIAL COMPLIANT ROHS STANDARD

REVISION INFORMATION			
Rev.	Rev. Date	Modified By	Brief Description

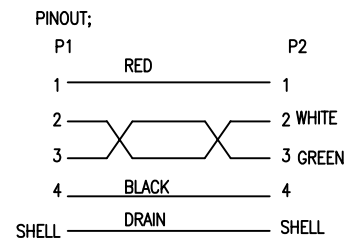

NOTES:
 1) PRIMARY DIM: A. B
 2) RoHS compliant.

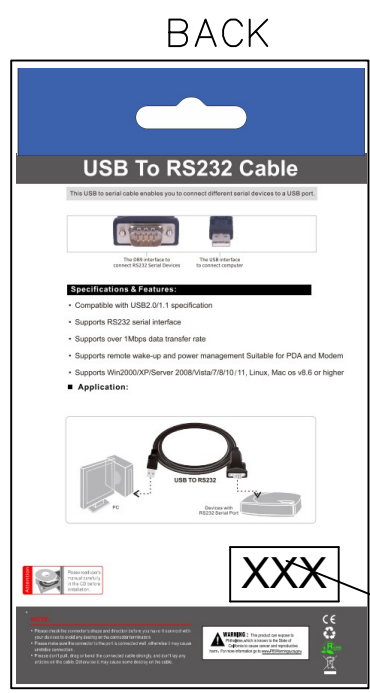
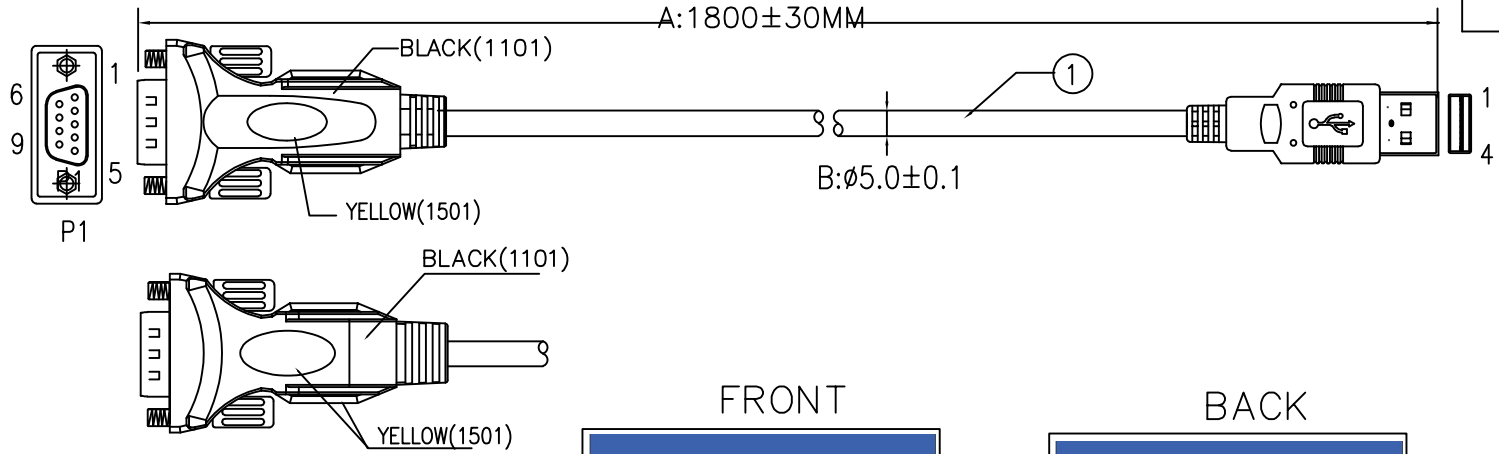

NO.	PART NAME	SPECIFICATION DESCRIPTION	QTY	UNIT
③		USB1.1 TO RS232 CABLE PCBA(Prolific Chipset PL2303GT) RoHS		
②		USB1.1 A/M WHITE SOLDOR TYPE RoHS		
①		UL2725 28#1P+24#2C+A+B(32AM)+D(BA) OD: 5.0MM BLACK(1101) 1800MM RoHS		

DRAWN BY	DATE: 2022/07/07	DESCRIPTION: USB1.1 TO RS232 CABLE	
CHECKED BY	SHEET 1 of 3	ITEM NO. 150487	
APPROVED BY	SCALE 1:1	REV. 00	UNIT: mm

Unless specified on the drawing, tolerances are per the fo llows:
 . +1
 .x +0.2
 .x +0.05

DATE CODE: MONTH CODE + YEAR CODE
 EX: 2021 YEAR 8 MONTH
 DATE CODE : 088

NOTE: ALL MATERIAL COMPLIANT ROHS STANDARD

REVISION INFORMATION			
Rev.	Rev. Date	Modified By	Brief Description

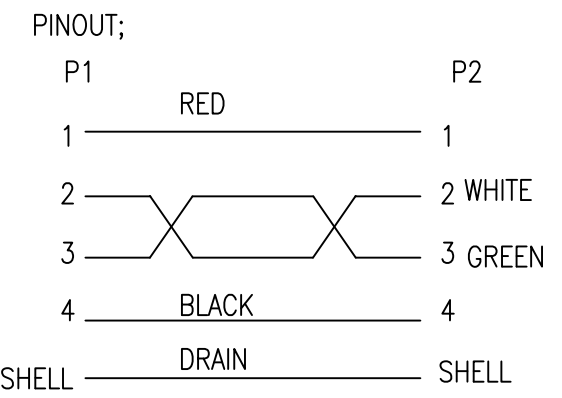
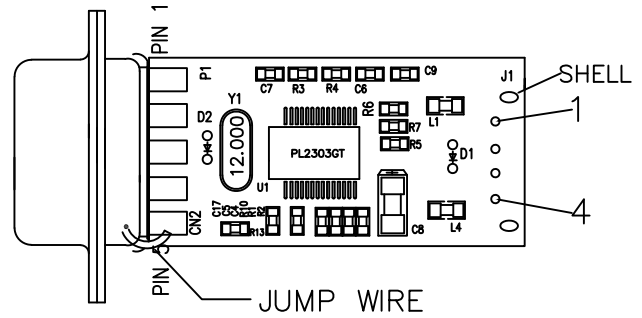
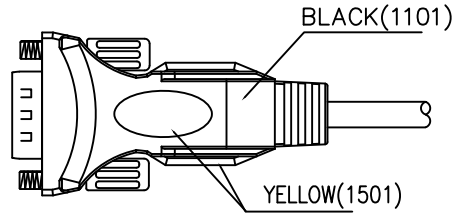
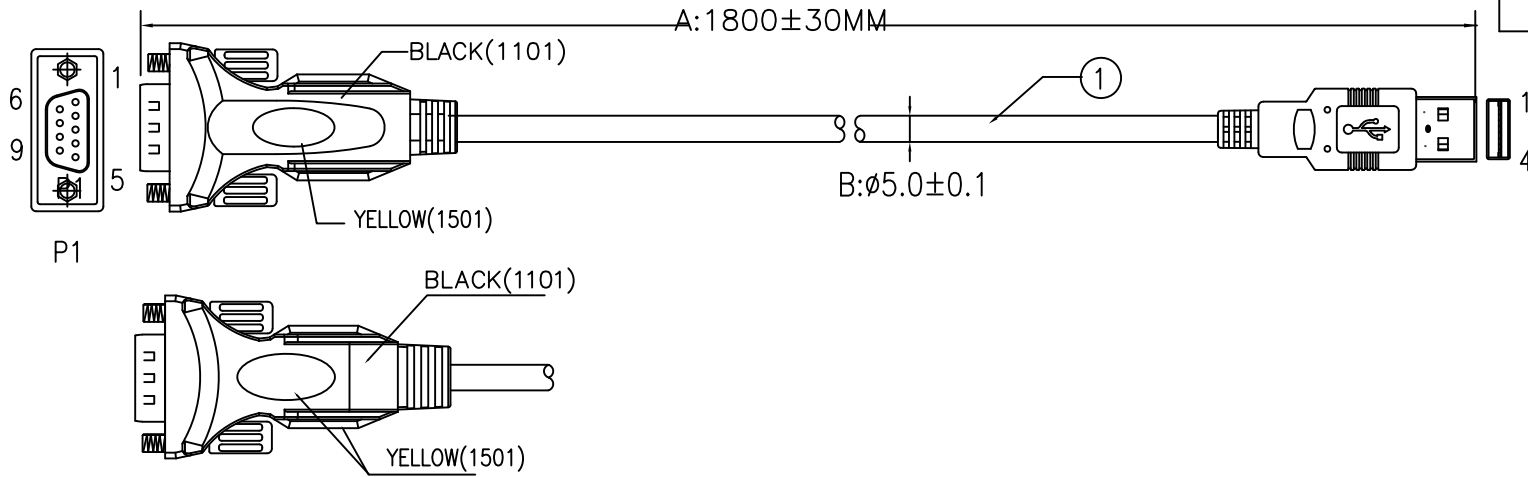

- NOTES:
- 1) PRIMARY DIM: A. B
 - 2) RoHS compliant.



③		USB1.1 TO RS232 CABLE PCBA(Prolific Chipset PL2303GT) RoHS			Unless specified on the drawing, tolerances are per the fo llows: . +1 .x +0.2 .x +0.05
②		USB1.1 A/M WHITE SOLDOR TYPE RoHS			
①		UL2725 28#1P+24#2C+A+B(32AM)+D(BA) OD: 5.0MM BLACK(1101) 1800MM RoHS			
NO.	PART NAME	SPECIFICATION DESCRIPTION	QTY	UNIT	

DRAWN BY	DATE: 2022/07/07	DESCRIPTION: USB1.1 TO RS232 CABLE
CHECKED BY	SHEET 2 of 3	ITEM NO. 150487
APPROVED BY	SCALE 1:1	REV. 00 UNIT: mm