

NOTE: CARTON MATERIAL MUST BE A=A

REVISION INFORMATION			
Rev.	Rev. Date	Modified By	Brief Description
1.0	2021/04/13	Darrick	Change Label

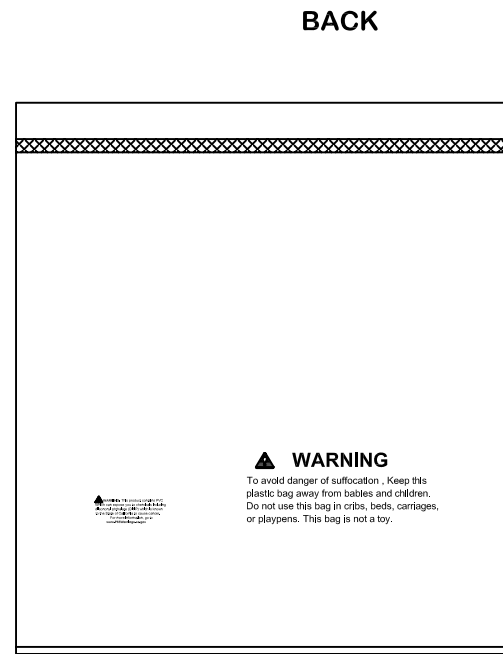

300pcs →

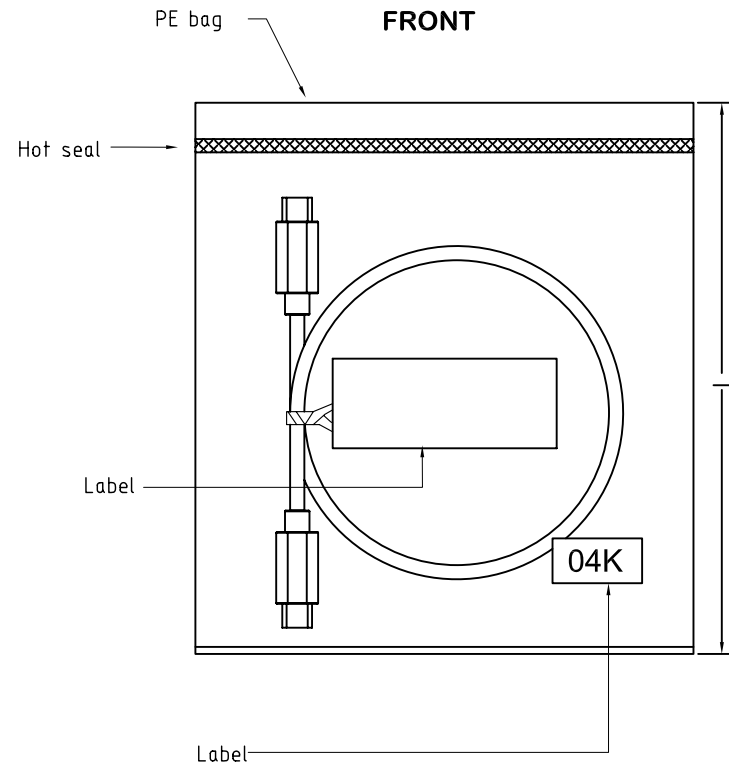
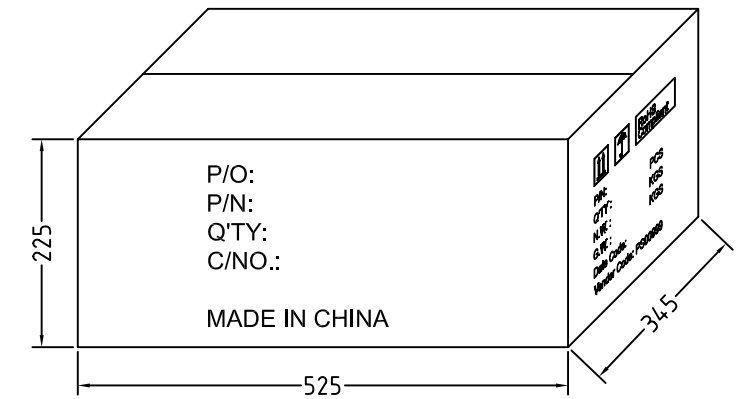

**MAIN MARK**

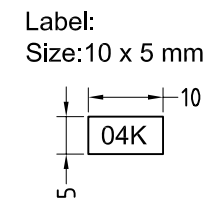
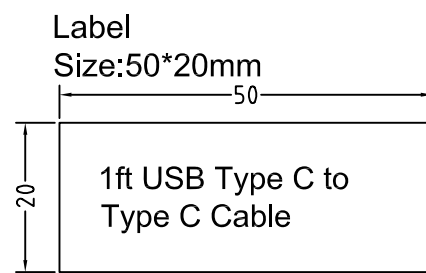
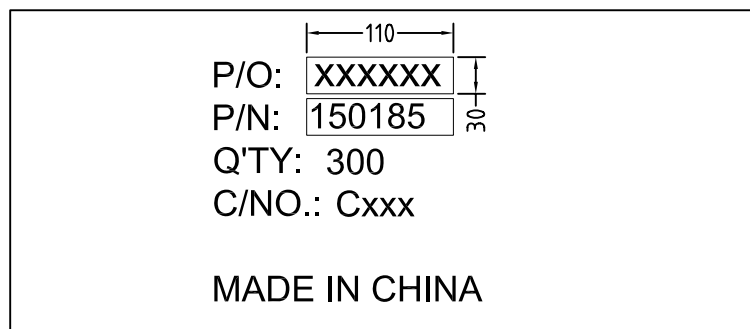

Label  
Size: 110\*70mm

**Packing Instruction:**

1. Coil the cable (see attached). Secure the cable with cable tie, and then pack each cable with an PE bag, The label is attached to the OPP bag.
2. Seal the PE bag ,
3. Use a waterproof bag to pack the products before going into master carton. Make sure each individual cable is staggered and positioned tidily. A paperboard is needed in both the bottom and the top of the products.
4. See shipping mark on the left.

**SIDE MARK**

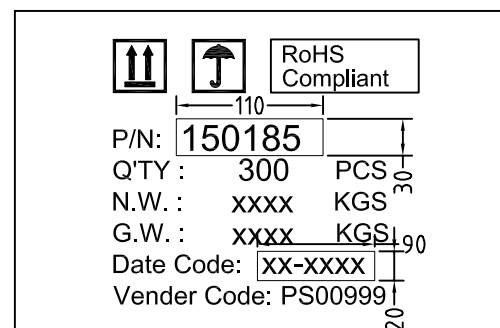

Carton Size: 20.67"(L)\*13.58"(W)\*8.86"(H)  
 Carton Quantity: xxx pcs  
 Carton Weight: xxxx LBS

DRAWN BY	DATE: 2021/04/13	DESCRIPTION: USB TYPE C TO TYPE C CABLE
CHECKED BY	SHEET 2of2	ITEM NO. 150185
APPROVED BY	SCALE None	REV. 1.0
	UNIT:mm	